

# systemer®



[Main Catalog](#)

**TANOS**

UNIQUE. PATENTED. UNSURPASSED.  
STACKABLE. LINKABLE. THE systainer®  
IS NOT JUST A CASE, IT'S A SYSTEM.

NEW



### Systainer³



Even more reliable, with more functions and broader applications – that's Systainer³. The third generation stands for even better mobility with a comprehensive mobility concept. Enjoy the advantages you trust with the Systainer³: T-Loc central controller, compatible with one another and connectable with all previous systainer® generations.



### systainer® T-Loc



Just one touch is all you need! Systematically stack individual systainer® and lock them with a flick of the wrist – this generation offers innovative T-Loc central controller technology: lock, open, connect. The second generation combines innovation with function and attractive design.



### systainer® Classic-Line



Proven top class quality! Our systainer® Classic-Line has been accompanying millions of satisfied customers through their everyday work for many years. Of course, it can be combined with all other systainer® generations.

## TANOS systainer®

Page 4 - 17

<b>From the past to the future</b>	Page 4 - 5
<b>systainer® applications</b>	Page 6 - 7
<b>More than just a case</b>	Page 8 - 9
<b>Distinctive</b>	Page 10 - 13
<b>systainer® system partners</b>	Page 14 - 15
<b>Systainer<sup>3</sup> connects</b>	Page 16 - 17



## systainer® – CONVINCING ARGUMENTS

Page 18 - 29

<b>Linkable</b>	Page 18 - 19		
<b>Quick &amp; Easy</b>	Page 20 - 21		
<b>Mobile</b>	Page 22 - 23		
<b>Multifunctional</b>	Page 24 - 25		
<b>Reliable</b>	Page 26 - 27		
<b>Versatile</b>	Page 28 - 29		

## systainer® PRODUCT RANGE

Page 32 - 87

# TANOS

systainer®

## FROM THE PAST TO THE FUTURE

TANOS GmbH was founded in 1993 as a subsidiary of TTS Tooltechnic Systems AG & Co. KG. Developing and distributing the systainer® product range is our passion. Secure packaging and clear organization of your work materials and tools, and saving time during transportation – systainer® products provide all of these benefits and more. As the inventors of this unique, patented case system, we have created cases that can be stacked and linked together. Our concept makes a systainer® more than just a case: It's a system!



### 1993 systainer® Classic-Line

The systainer® success story begins. Thanks to TANOS systainer® products are available to everyone.



● **1 millionth**  
systainer® sold in 1996.

● **10 millionth**  
systainer® sold in 2008.

### 2010 systainer® T-Loc

Global debut:  
Market launch of the second systainer® generation with unique T-Loc central controller.



● **20 millionth**  
systainer® sold in 2015.

● **25 millionth**  
systainer® sold in 2018.

● **2018**  
TANOS goes USA:  
The founding of TANOS Inc./USA ensures systainer® is now directly available in the USA as well.

2018

New standard for mobile work:  
The mobile workshop MW 1000.



2019  
**Systainer<sup>3</sup>**

**Market launch of the innovative third generation: 100 % mobile, simply practical, better in a system. Cooperation between TANOS, bott and Festool to develop a comprehensive, consistent mobility concept.**



2020

The Systainer<sup>3</sup> system has won numerous design awards for outstanding design quality.



2020

Think big – Systainer<sup>3</sup> XXL with plenty of space and volume!



2021

German Brand Award – Special Mention in the category "Excellent Brands – Tools and Gardening". for outstanding brand work by TANOS.



2021

New Systainer<sup>3</sup> ToolBox – the convertible Version expands the Systainer<sup>3</sup> System.



2022

Foundation of the joint venture Systainer Systems North America, LLC of bott and TANOS for the marketing of systainer<sup>®</sup> and bott Smartvan in the USA/North America.



2022

Everything sorted and organized: Systainer<sup>3</sup> lid compartment M in 3 heights completes the system.



2023

30 Years TANOS



2023

Systainer<sup>3</sup> ToolBag M: Flexible organization with leading design.



2023

Systainer<sup>3</sup> Eco: Mobile system case in a sustainable version – the first of its generation made from sustainable recycled material.



40 millionth

systainer<sup>®</sup> sold in 2024.

2024

Systainer<sup>3</sup> Combi M + Systainer<sup>3</sup> Sortainer M: New sorting and storage solutions for workshops, vehicles and construction sites.



2024

Systainer<sup>3</sup> Rack: Mobile small parts rack for every need



2024

Systainer<sup>3</sup> S 76 + 147: The space saver for storing small parts.



# TANOS

systemer®

## A SMALL SELECTION OF systemer® APPLICATIONS

**TRADES**

**INDUSTRY**

**MEDICAL**

**SALES REPRESENTATIVE EQUIPMENT**

**SPORTS & LEISURE**

**VEHICLE EQUIPMENT**



### A SOLUTION FOR ANY JOB



Whether you're a do-it-yourselfer or an nationwide trade company, the systemer® is custom-tailored to fulfill your needs and requirements.



If you want to sell and present your products with a high-quality image, the systemer® is a perfect building block in your brand strategy.



Safety and reliability in transportation and handling are essential in the medical field. A systemer® impresses everywhere and anytime.

## IN USE EVERYWHERE

Your systainer® system offers an endless range of potential applications, in many different industries and sectors. Clearly, systainer® products are a popular choice in trades and industrial applications. But systainer® are also an all-around system built to handle specialized demands and requirements. Innovative developments, accessories, variables, a variety of internal features and easy linking options make the systainer® a smart system for your needs.



### SALES REPRESENTATIVE EQUIPMENT

Put your products in the limelight! systainer® offers individual, customized solutions for product presentation, for even more successful field sales.



### SPORTS & LEISURE

Whether sport fishing or climbing – a systainer® is the perfect choice to store all your sporting equipment in one place.



### VEHICLE EQUIPMENT

Our systainer® can be integrated as part of your vehicle equipment. Mobile and flexible – make your work more effective.

# TANOS

systainer®

## STACKABLE AND LINKABLE

Individual systainer® can be combined, securely stacked, firmly linked and can still be operated individually at the same time.



## TRANSPORT OPTIMIZATION

Standardized dimensions sized for Euro pallets allow boxes to be stacked across the whole surface, saving volume and cash during transportation on pallets – whether in a truck, a warehouse, or a retail store.

## LONG-LASTING DESIGN

If it breaks, fix it!  
All systainer® components, such as lids, handles and catches can be replaced.

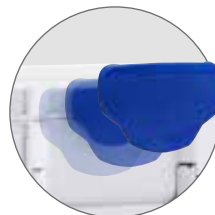

## ABS\* PLASTIC

The best base material combined with a sturdy design offers outstanding structural strength.



\*ABS = Acrylnitril-Butadien-Styrol



## VARIETY OF COLORS

Besides our standard colors, additional colors are available. In addition, colors for the catch, handle and body can be selected individually for custom combinations. No minimum order required.



## DESIGNED IN GERMANY

### DEVELOPED IN HOUSE

Our research and development department with highly qualified engineers and product managers works continuously on the innovative further development of our products with ISO 9001 certification.

### HIGHLY AUTOMATED PRODUCTION

Thanks to standardized processes, we guarantee consistent, high product quality and quality controlling in Germany and Europe.

### ENVIRONMENT & SUSTAINABILITY

The systainer® produced from recyclable ABS ensure more environmentally friendly, recyclable packaging you can use for years, and therefore help to avoid waste.



## MORE THAN JUST A CASE

Today, flexibility on the job is essential. Each and every systainer® is not just a case, but rather part of a cleverly designed system. This allows you to prepare for and react optimally to your work needs. The different possible combinations, and variable interior options for your systainer® are virtually endless. Easily change the arrangement of your systainer® tower to meet your personal needs. All systainer® are stackable and linkable!



### AWARD-WINNING systainer® T-LOC SYSTEM

Multiple awards and consistently positive test results are truly a reflection of the enthusiasm for innovative technologies and the long-lasting, high quality standard of this system.



### STILL THE ORIGINAL

The entire systainer® portfolio is fully protected by a various property rights. The original systainer® is and remains an original. You can rely on that.

# TANOS

systainer®

## HOW TO DESIGN A CUSTOM systainer®

### Step 1: Describe the problem

Do you need a packaging solution for your products, or an organizational, presentation or transportation system? No matter what quantity you need, ask us! We want to be your partner.

### ADDITIONAL SERVICE

#### Step 6: Shipment

We are happy to handle shipping logistics for you, and ensure your systainer® arrive safely.

### ADDITIONAL SERVICE

#### Step 5: Assembly

You send your product and we package it. Upon request, we can attach your custom label and even purchase third party products.



### Step 2: Find the solution

Standard product range, or specially tailored to meet your needs? We are happy to develop the interior features you need, and build a sample if necessary.

### Step 3: Corporate design

Use the systainer® as a product and brand ambassador. We will be happy to advise you and present a variety of options to you.

### Step 4: Market launch

Your custom systainer® is ready for use.

**TIP:** Offer your custom designed systainer®, even without inserts. Color matched and with your own logo!

### YOUR PACKAGING SOLUTION – THE systainer®

We have already implemented countless customized products in collaboration with our partners. Specialized bottom and lid inserts, deep drawn parts matched to your product or one and two color foam – your customization options know no limits. Ask us, we will be happy to professionally handle your requirements.



## DISTINCTIVE

Each and every systainer® is important to us. Whether you choose a standard version with available system components or a custom special design tailored to your needs. We support you, from initial idea to delivery. Design, color, interior features, formats, or applications: we look forward to presenting the countless possibilities of the systainer® system to you. Benefit from the case system already used by numerous well-known manufacturers.

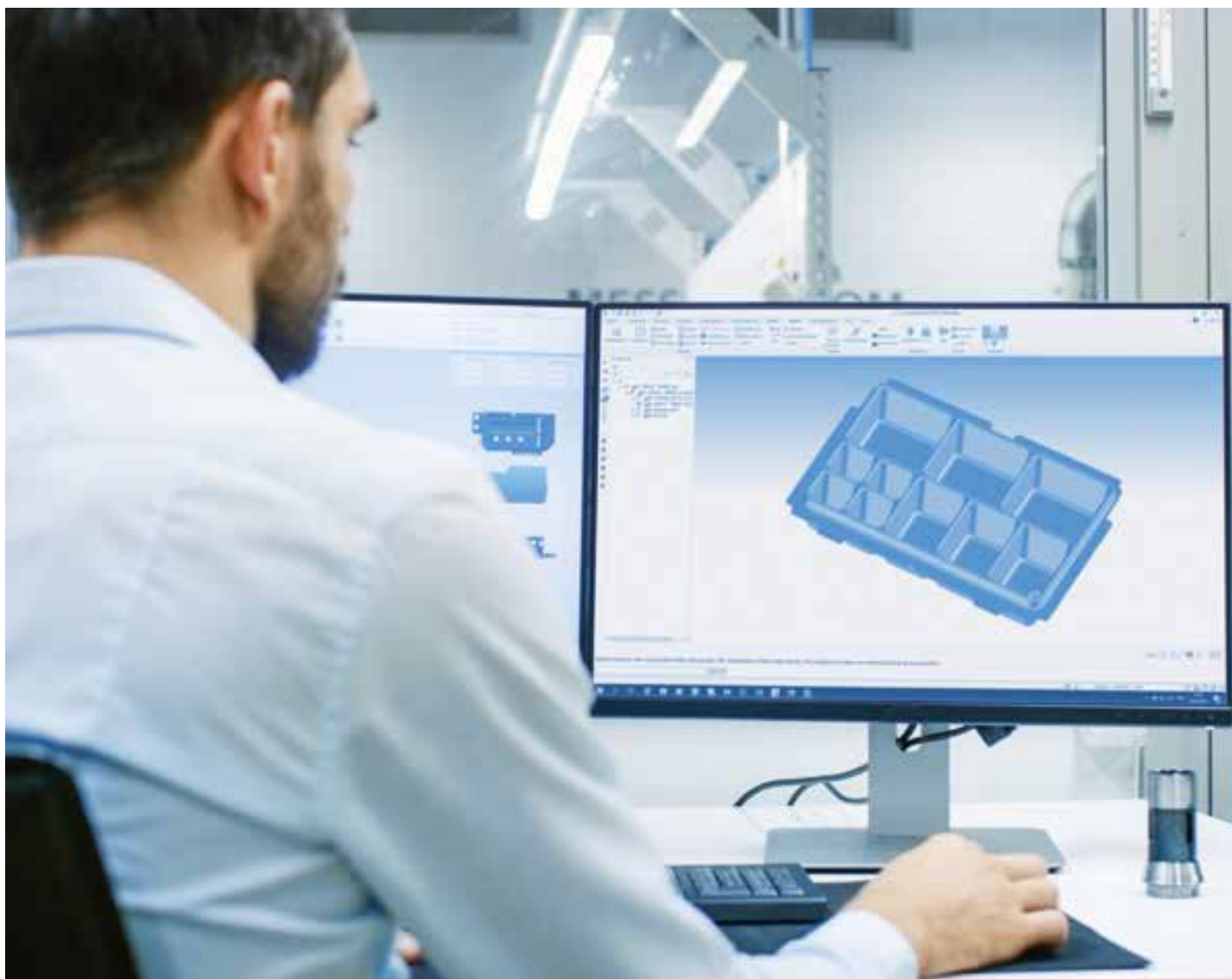

### THEFT-TAG – BETTER SAFE THAN SORRY

Benefit for manufacturers and dealers: the “Theft Tag” closure is integrated directly on the Systainer<sup>3</sup>. All-around theft protection: everything safe and enclosed. No more illicit removals of products. Also a major advantage in the medical sector, e.g. for sealing medical examination materials.



# TANOS

systainer®

## CORPORATE DESIGN

No brand strategy without branding. Whether you want to add your company logo or your slogan – even with small quantities, you can print the body, lid and catches with multiple colors. Thanks to the modular design, you can assemble your own systainer® from our extensive color palette. Brand recognition guaranteed!

## LABELING

Simple and practical labeling of your systainer® with labeling sets for card inserts.



## CONFIGURATION

Simple and innovative system to design your custom systainer® in just a few steps.



Lid handle



Lid



Catch body



Pin



Catch cover



Body



Pull-out aid  
(≥ 237)



Front handle  
(≤ 187)



## EXTRA TIPS

## PERFECT CUSTOMIZATION

At larger order quantities, we can also emboss your product or company brand directly to the right and left of the edge of the lid or on the lid of your systainer®.





## COLOR PALETTE





Do you prefer bright and colorful or discreet and reserved? We offer our timeless standard design in light grey with signal blue catch or all anthracite at no additional charge.

Numerous additional RAL color shades are available ex works. Do you need a custom color? No problem, we will be happy to advise you!

## STANDARD COLORS

	RAL 7035, light grey
	HKS 43 K, signal blue
	RAL 7016, anthracite

## ADDITIONAL COLORS

	RAL 9004, black		RAL 3002, carmine red		RAL 6001, emerald green
	RAL 1007, daffodil yellow		RAL 5015, sky blue		HKS 54 K, signal green
	RAL 2011, deep orange		RAL 5003, sapphire blue		RAL 9016, white

## IT'S WHAT'S INSIDE THAT COUNTS

Ask us! We will provide you with professional support and advising, no matter your idea or requirement. Whether you plan to use the systainer® as packaging or to present your products, to transport sensitive goods or to equip your workshops or production warehouses in an organized way – we will construct, develop and design your custom systainer® solution to precisely meet your needs.

### Standard product range



### Special design



## YOUR PRODUCT AMBASSADOR

You can even use the interior areas as an advertising surface! Use the systainer® lid for important product information or user instructions.



# TANOS

systainer®

## systainer® SYSTEM PARTNERS: A SMALL EXCERPT



### i

## IMPRESSIVE NUMBERS

### 63 DIFFERENT systainer® VARIATIONS

Innovation and creativity are the drivers behind everything we do. We don't just want to fulfill your requirements; we also want to meet your needs.

### AN ENDLESS RANGE OF COMBINATIONS

systainer® does what you want! Virtually unlimited possibilities allow for perfectly tailored customization.

## EVERYTHING BUILDS ON THE systainer®

As the manufacturer of the most popular linkable case system on the market, we believe in the power of experience: To get where you're going, you've got to know where you've been! The success of the systainer® proves us, and you, right. We'd like to say a huge thank you to our customers and partners! Over 40 million systainer® sold have made our system what it is today. You can build on the systainer®, since 1993. It's here today, and it will be here tomorrow as well. We promise.



### **MORE THAN 40 MILLION systainer®**

A big thank you to our customers and partners! The systainer® is conquering the world and we are delighted with more than 40 million sold systainer®.

### **3 PRODUCT LINES, 1 SYSTEM**

Systainer<sup>3</sup>, systainer® T-Loc, systainer® Classic-Line: Unique, clever, stackable, and linkable. Together, on top of one another, and across brands.

**MILLIONS  
OF SATISFIED  
USERS SPEAK FOR  
THEMSELVES.**

**systainer<sup>®</sup>**  
The new generation

## Systainer<sup>3</sup> CONNECTS

Custom-tailored vehicle integration for simple and secure transportation. With a uniform packaging and transportation system, optimally integrated into a vehicle equipment, Systainer<sup>3</sup> keeps everything clearly organized and safely stowed, from your stationary workshop to your mobile work site.

TANOS, bott and Festool have worked together to develop a mobility system that integrates perfectly with the bott vario3 in-vehicle equipment. Now, you can take the order and the simple handling of the systainer<sup>®</sup> system, safely with you in your vehicle. You benefit from a well thought-out mobility concept and an even more professional image toward your customers.





# Systainer<sup>3</sup> CONNECTS SOLUTIONS

## LINKABLE

"With systainer<sup>®</sup>, I've got a friend for life."

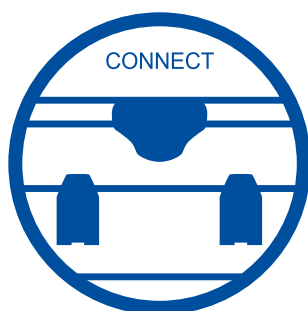

## VERSATILE

"With systainer<sup>®</sup>, I'm working with a system."

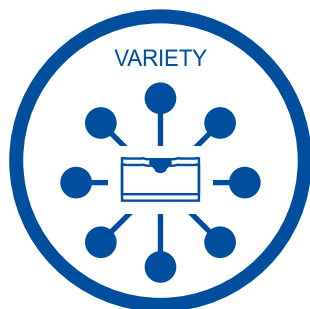

## QUICK & EASY

"The systainer<sup>®</sup> makes my everyday work easier."



## Trusted

T-Loc central controller

## Secure

Theft-tag catch system

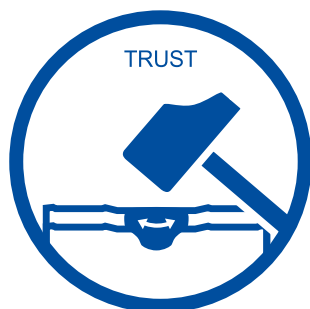

## RELIABLE

"With systainer<sup>®</sup>, I've got a reliable partner."



## MULTIFUNCTIONAL

"The systainer<sup>®</sup> does what I want."



## MOBILE

"The systainer<sup>®</sup> is a perfect fit for 100% mobility."

**systemer**<sup>®</sup>  
The new generation

WITH SYSTAINER  
I'VE GOT A FRIEND  
FOR LIFE

**Systainer<sup>3</sup>**

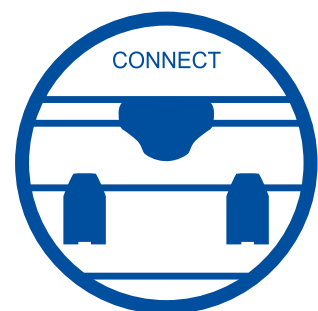

## LINKABLE

Stackable and linkable – our market-leading, patented case system helps millions of users with their everyday work. systainer® impress in everyday use. They link together quickly, saving lots of time and unnecessary walking. systainer® towers can be carried with a single handle, offering excellent convenience and mobility. Our new Systainer<sup>3</sup> product line impresses with the ability to link cases of different generations. They can be combined with existing systainer® product lines as well as with systainer® system partners.



### Stackable

Link systainer® to create a systainer® tower with a simple turn.

### Compatibility

All systainer® can be combined with one another.



### Versatile combinations

#### systainer® ToolBox

The perfect ToolBox – available in four sizes.



#### Systainer<sup>3</sup> ToolBag M

Flexible organization with leading design.



#### Systainer<sup>3</sup> Combi + Sortainer M

Sorting and storage solutions for workshops, vehicles and construction sites.



**systainer**<sup>®</sup>  
The new generation

THE SYSTAINER  
MAKES MY EVERYDAY  
WORK EASIER

**Systainer<sup>3</sup>**



## QUICK & EASY

Easy to operate and convenient in everyday work. Close, open and link using trusted, patented and unique T-Loc central controller. Easily access contents, connect or remove systainer® with just one hand and just one turn. In addition, transportation is easier than ever before with the Systainer³. Whether upright, individually or as a linked tower.



### Open while linked

Access contents with just one motion, without breaking the links between cases.



### Pull-out aid

Above size 237, a pull-out aid makes it easier to remove the case from a shelf or vehicle.



### One hand operation

Close, open and link with just one turn.

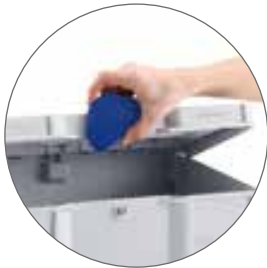

### Front handle

Systainer³ M + L 112-187 and Systainer³ Organizer M + L can also be carried upright thanks to their front handles and well thought-out design.



### Automated

Lid closes easier thanks to our optimized design.

### Easy transportation

Easily transport cases individually or as a tower using the front handle, or the lid handle. Move faster and enjoy better convenience with the Systainer³.



### TIP: Innovative labeling

Know what's inside! Two slots for custom labeling.



**systainer**<sup>®</sup>  
The new generation

THE SYSTAINER  
OFFERS A PERFECT FIT  
FOR 100% MOBILITY

**Systainer<sup>3</sup>**



## MOBILE

Use all the advantages of the systainer® system and benefit from the additional mobility offered by the third generation, which was a specific focus during development. It makes everyday work even easier for professional users, from the workshop to the construction site. Save space, time and strengthen your reputation with the Systainer<sup>3</sup>.



### Perfect use of space

systainer® use standardized grid dimensions for optimal use of space in the vehicle, meaning they fit into many common vehicle equipment systems.

### Access made easy

With the pull-out aid and optimized lid handle, the Systainer<sup>3</sup> is easier to remove and use quickly.



### Even simpler transportation

The new generation has redefined a combination of convenience and function. The Systainer<sup>3</sup> can be stowed easily and quickly, secure for transportation without any additional rail elements in both vario3 van racking.



**systainer**<sup>®</sup>  
The new generation

THE SYSTAINER  
DOES WHAT  
I WANT



**Systainer<sup>3</sup>**

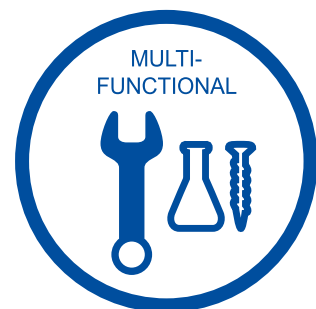



## MULTIFUNCTIONAL

The variable features offered for systainer® are the alpha and omega for meeting any requirement. With accessories, lid and bottom inserts, organizing and sorting systems and a larger selection of heights and widths, the new generation Systainer³ offers an almost limitless range of variations for any need. Clear and simple, with optimal usage of space. The systainer® stands up to any challenge; there's always a systainer® solution.



### Systainer³ Rack M:

The mobile small parts rack for the construction site, workshop and when on the road. The Systainer³ Rack with the practical storage solution for a total of six Systainer³ S 76.



### For fans of structure:

Small parts sorting for professionals. With Systainer³ Organizer and its insert boxes, every small part has its place and is clearly sorted.



### Systainer³ Organizer in two sizes

In addition to the M 89 size, the L 89 variation is available for even broader sorting options.

### Storage

Molded compartments for your tools, with user-friendly packaging. From universal to specialized inserts, the systainer® has the right option for your specific needs.



### Space saver

Optimal use of available space.



### Clearly organized

Clearly organized storage and availability for materials you use every day. Everything at a single glance!



### Big, bigger, Systainer³

With XXS-XXL sizes, the Systainer³ generation offers a large spectrum of heights and widths. The right size for every requirement.



**systainer**<sup>®</sup>  
The new generation

WITH SYSTAINER  
I HAVE A  
RELIABLE PARTNER

**Systainer**<sup>3</sup>



## RELIABLE

All Systainer<sup>3</sup> offer outstanding strength thanks to their ABS\* base material, combined with an innovative and stabilizing design structure. Your products are always safely stored, reliably packaged, and ready for transportation at any time with a Systainer<sup>3</sup>. With the Systainer<sup>3</sup> quality case system, you have a reliable partner for your everyday work.



### HARD SHELL

Perfect combination: excellent ABS\* material and a stabilizing design structure with the additional lid hinge and optimized "base cross" mean the Systainer<sup>3</sup> offers a highly rugged design.

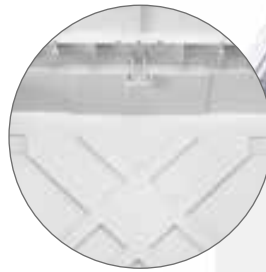

### SOFT CORE

A Systainer<sup>3</sup> doesn't bend easily. Sensitive contents are well protected in the Systainer<sup>3</sup>.

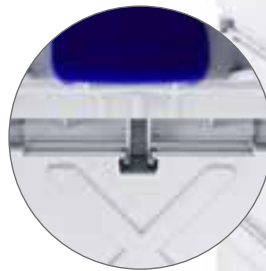

### Impact protection

Padding combination for maximum interior dampening. Even highly breakable goods are fully protected against damage.

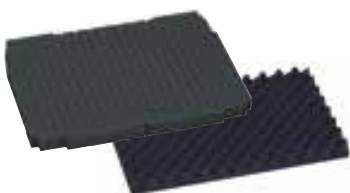

### Vibration-protected transportation

Every part remains in its place. Perfect-fit lid inserts ensure a solid, secure closure.



Systainer<sup>3</sup> S  
with dividers

### Did you know?

systainer<sup>®</sup> is often used in the medical field.



\*ABS = Acrylnitril-Butadien-Styrol

**systainer**<sup>®</sup>  
The new generation

WITH SYSTAINER  
I'M WORKING  
WITH A SYSTEM

**Systainer<sup>3</sup>**

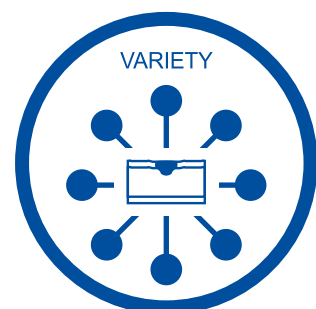

# VERSATILE

It's not just a case, it's a system! The TANOS portfolio includes not only the innovative systainer® case system, but also an extensive range of practical accessories. From stationary work to transportation to the job site and mobile work directly on site, TANOS offers a wide range of solutions to work even better with a system. No matter how unusual your needs might be, you can rely on our creative product solutions and continuously growing range of innovations.



Perfect storage and work in the workshop with systainer®.

Product selection



Systainer³ BASE-Wall/base support



Drawer "SYS-AZ"

Secure your load and protect your health with our mobile accessories range.

Product selection



Systainer³ CART „SYS-RB“



Transport trolley "SYS-ROLL"

Innovative systainer® solutions that allow you to work efficiently, anytime and anywhere.

Product selection



Mobile workshop MW 1000

... and much more.



## FLEXIBLE AND MOBILE ON THE GO

As the manufacturer behind the systainer® connectable storage system – which has sold millions of units to date – we always have our eye on the latest trends. Today, flexibility and mobility are central facets of everyday work for most tradespeople. Our mobile workshop offers the flexibility you need, ensuring it is ready to use for any application. Compact, comfortable, and with maximum portability, the mobile workshop can be set up anywhere you need it. That's efficiency that pays off!

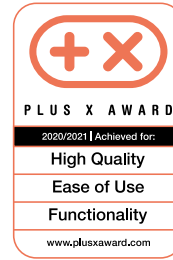

### SAFE

- Safely attach work surface to the cart for transportation using the integrated strap



### MULTIFUNCTIONAL

- Flexible clamping mounts on all sides
- Can be connected to additional work tables (TSB/1-MW 1000) on all sides
- Even, stable and consistent work surface



### EASY TO USE

- Simple to handle and transport, even on your own



### STURDY

- Adjustable feet
- Cart stands on four feet – not on the rollers

**Robust:** Trolley and wheels easily handle uneven surfaces



**Independent:** The mobile workshop is ready to use whenever and wherever you need it



**Sturdy:** The stable construction ensures optimal working conditions anywhere



**Ready to go!** Quick storage and everything in place for the next job site



**FLEXIBLE**

- Integrated MDF work surface for safely attaching additional systainer® (suitable for all systainer® generations.)



**ORGANIZED**

- Stable drawer (SYS-AZ-MW 1000)
- Perfect fit for mounting systainer® with base area of W 396 x D 296 mm
- Custom fitting with drawers
- Variable height adjustment without tools



**RELIABLE**

- T-Loc catch to attach the systainer® to the mobile workshop



**PRACTICAL**

- Easily load into a vehicle with sliding surfaces on the handle



**INTUITIVE**

- Three different position settings – locks automatically



**STURDY**

- Large rubber wheels, 200 mm diameter for easily climbing stairs, without gravel residue or visible wear to floors

**CLEVER**

- Storage for MINI-systainer® T-Loc I or Systainer® S in the base tray
- Additional drawer can be retrofitted (SYS-AZ art. no. 80101664)



# systemer<sup>®</sup>

Product range





# OUR PRODUCT RANGE

## EMPTY-**systainer**<sup>®</sup>, SETS AND INSERTS

**systainer**<sup>®</sup> dimensions



Page 34 - 35

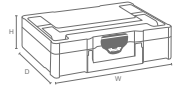

**Systainer**<sup>3</sup> M



Page 36 - 47



**Systainer**<sup>3</sup> L



Page 48 - 53



**Systainer**<sup>3</sup> XXL



Page 54 - 55



**Systainer**<sup>3</sup> Organizer



Page 56 - 59



**Systainer**<sup>3</sup> ToolBox



Page 60 - 61



**Systainer**<sup>3</sup> lid compartment M



Page 62 - 63



**Systainer**<sup>3</sup> Combi M,  
Sortainer M, Rack M



Page 64 - 69



**Systainer**<sup>3</sup> S



Page 70 - 73



**Systainer**<sup>3</sup> ToolBag



Page 74 - 75



**systainer**<sup>®</sup> Storage-Box



Page 76 - 77



## **systainer**<sup>®</sup> ADDITIONS AND ACCESSORIES

Labelling

Page 78



Safety, Systainer<sup>3</sup> XXS

Page 79



Mobile work

Page 80 - 82



Stationary work

Page 83



Spares

Page 84 - 87



Detailed product information can be found under [www.TANOS.de](http://www.TANOS.de)

# SYSTEMER<sup>®</sup> DIMENSIONS

Sizes from XXS to XXL! Well-conceived and perfectly matched dimensions make it easy for you to adapt our systemer<sup>®</sup> optimally to your requirements to save space.

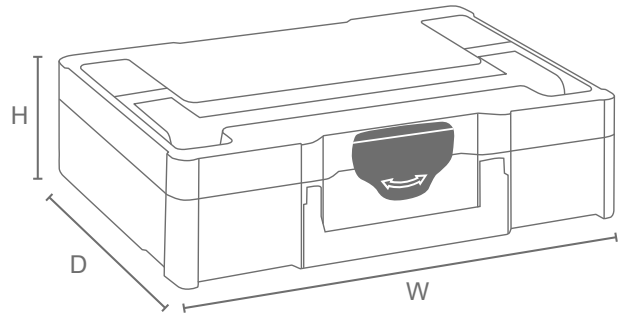

## Systemer<sup>3</sup>



	Outside in mm	Inside in mm	Weight	Inner volume	Pallet Pcs. / H.
<b>Systemer<sup>3</sup> M 112</b> 1)	H* 105 x W 396 x D 296	H 71 x W 389.5 x D 275	1.40 kg	7.7 l	128 / 183.7 cm
<b>Systemer<sup>3</sup> M 137</b> 2)	H* 130 x W 396 x D 296	H 96 x W 389.5 x D 275	1.50 kg	10.4 l	104 / 184.7 cm
<b>Systemer<sup>3</sup> M 187</b> 3)	H* 180 x W 396 x D 296	H 146 x W 389.7 x D 275.2	1.69 kg	15.9 l	72 / 177.7 cm
<b>Systemer<sup>3</sup> M 237</b> 4)	H* 230 x W 396 x D 296	H 196 x W 389.7 x D 275.2	1.89 kg	21.4 l	56 / 176.7 cm
<b>Systemer<sup>3</sup> M 337</b> 5)	H* 330 x W 396 x D 296	H 296 x W 389.7 x D 275.2	2.35 kg	32.4 l	40 / 180.7 cm
<b>Systemer<sup>3</sup> M 437</b> 6)	H* 430 x W 396 x D 296	H 394 x W 389.7 x D 275.2	2.89 kg	43.1 l	32 / 187.7 cm



	Outside in mm	Inside in mm	Weight	Inner volume	Pallet Pcs. / H.
<b>Systemer<sup>3</sup> L 137</b> 7)	H* 130 x W 508 x D 296	H 94 x W 501.5 x D 275.2	1.92 kg	13.2 l	52 / 184.7 cm
<b>Systemer<sup>3</sup> L 187</b> 8)	H* 180 x W 508 x D 296	H 144 x W 501.7 x D 275.2	2.14 kg	20.2 l	36 / 177.7 cm
<b>Systemer<sup>3</sup> L 237</b> 9)	H* 230 x W 508 x D 296	H 194 x W 501.7 x D 275.2	2.38 kg	27.4 l	28 / 176.7 cm



	Outside in mm	Inside in mm	Weight	Inner volume	Pallet Pcs. / H.
<b>Systemer<sup>3</sup> XXL 237</b> 10)	H* 230 x W 792 x D 296	H 188 x W 786.5 x D 279.1	3.64 kg	42.3 l	28 / 176.7 cm
<b>Systemer<sup>3</sup> XXL 337</b> 11)	H* 330 x W 792 x D 296	H 288 x W 786.1 x D 279.1	4.33 kg	64.2 l	20 / 180.7 cm



	Outside in mm	Inside in mm	Weight	Inner volume	Pallet Pcs. / H.
<b>Systemer<sup>3</sup> Organizer M 89</b> 12)	H* 82 x W 396 x D 296	H 60 x W 389.5 x D 246.2	1.60 kg	7.4 l	160 / 183.7 cm
<b>Systemer<sup>3</sup> Organizer L 89</b> 13)	H* 82 x W 508 x D 296	H 60 x W 501.5 x D 278.5	1.99 kg	9.7 l	80 / 183.7 cm

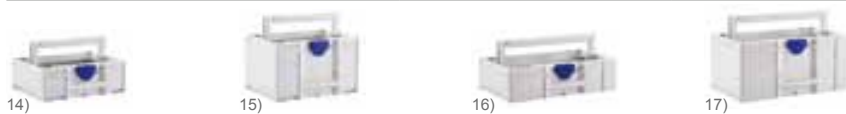

	Outside in mm	Inside in mm	Weight	Inner volume	Pallet Pcs. / H.
<b>Systemer<sup>3</sup> ToolBox M 137</b> 14)	H* 130 x W 396 x D 296	H 122 x W 357.8 x D 221	1.30 kg	10.4 l	104 / 184.7 cm
<b>Systemer<sup>3</sup> ToolBox M 237</b> 15)	H* 230 x W 396 x D 296	H 222 x W 357.8 x D 221	1.70 kg	21.4 l	56 / 176.7 cm
<b>Systemer<sup>3</sup> ToolBox L 137</b> 16)	H* 130 x W 508 x D 296	H 120 x W 461.1 x D 221	1.90 kg	13.2 l	52 / 184.7 cm
<b>Systemer<sup>3</sup> ToolBox L 237</b> 17)	H* 230 x W 508 x D 296	H 220 x W 461.1 x D 221	2.40 kg	27.4 l	28 / 176.7 cm



	Outside in mm	Inside in mm	Weight	Inner Volume	Pallet Pcs. / H.
<b>Systainer<sup>3</sup> lid compartment M 137</b> 18)	H* 130 x W 396 x D 296	H 96 x W 389.5 x D 275	1.70 kg	10.4 l	104 / 184.7 cm
<b>Systainer<sup>3</sup> lid compartment M 187</b> 19)	H* 180 x W 396 x D 296	H 146 x W 389.7 x D 275.2	1.90 kg	15.9 l	72 / 177.7 cm
<b>Systainer<sup>3</sup> lid compartment M 237</b> 20)	H* 230 x W 396 x D 296	H 196 x W 389.7 x D 275.2	2.10 kg	21.4 l	56 / 176.7 cm



	Outside in mm	Inside in mm	Weight	Inner Volume	Pallet Pcs. / H.
<b>Systainer<sup>3</sup> Combi M 287</b> 21)	H* 280 x W 396 x D 296	H 140 x W 389 x D 287	3.56 kg	–	48 / 183.7 cm
<b>Drawer</b>	–	H 66 x W 343 x D 271	–	–	–
<b>Systainer<sup>3</sup> Combi M 337</b> 22)	H* 330 x W 396 x D 296	H 190 x W 389 x D 287	3.72 kg	–	40 / 180.7 cm
<b>Drawer</b>	–	H 66 x W 343 x D 271	–	–	–



	Outside in mm	Inside in mm	Weight	Inner Volume	Pallet Pcs. / H.
<b>Systainer<sup>3</sup> Sortainer/2 M 337</b> 23)	H* 330 x W 396 x D 296	–	5.18 kg	–	40 / 180.7 cm
<b>Small drawer</b>	–	H 66 x W 343 x D 271	–	–	–
<b>High drawer</b>	–	H 158 x W 343 x D 261	–	–	–
<b>Systainer<sup>3</sup> Sortainer/3 M 337</b> 24)	H* 330 x W 396 x D 296	–	6.22 kg	–	40 / 180.7 cm
<b>Drawer</b>	–	H 66 x W 343 x D 271	–	–	–



	Outside in mm	Inside in mm	Weight	Inner Volume	Pallet Pcs. / H.
<b>Systainer<sup>3</sup> Rack/0 M 337</b> 25)	H* 330 x W 396 x D 296	–	4.06 kg	–	40 / 180.7 cm
<b>Systainer<sup>3</sup> Rack/6 M 337</b> 26)	H* 330 x W 396 x D 296	–	7.05 kg	–	40 / 180.7 cm



	Outside in mm	Inside in mm	Weight	Inner Volume	Pallet Pcs. / H.
<b>Systainer<sup>3</sup> S 76</b> 27)	H* 71 x W 265 x D 171	H 67 x W 258 x D 164	0.43 kg	3.2 l	400 / 200 cm
<b>Systainer<sup>3</sup> S 76 transparent lid</b> 28)	H* 71 x W 265 x D 171	H 67 x W 258 x D 164	0.46 kg	3.2 l	400 / 200 cm
<b>Systainer<sup>3</sup> S 147</b> 29)	H* 142 x W 265 x D 171	H 138 x W 258 x D 164	0.58 kg	5.8 l	192 / 195 cm



	Outside in mm	Inside in mm	Weight	Inner Volume	Pallet Pcs. / H.
<b>Systainer<sup>3</sup> Toolbag M</b> 30)	H* 359 x W 396 x D 296	–	3.68 kg	–	24 / 168.4 cm



## T-Loc / Classic-Line\*\*



	Outside in mm	Inside in mm	Weight	Pallet Pcs. / H.
<b>systainer<sup>®</sup> Storage-Box</b> 1)	H* 160 x W 396 x D 296 Height with handle*: 233	–	2.50 kg	88 / 196 cm

\*The outside dimensions are measured without feet: Systainer<sup>3</sup> M, L, XXL, Systainer<sup>3</sup> Organizer M + L, Systainer<sup>3</sup> lid compartment M, Systainer<sup>3</sup> Combi M, Systainer<sup>3</sup> Sortainer M, Systainer<sup>3</sup> Rack, Systainer<sup>3</sup> ToolBox M + L: H +7 mm; Systainer<sup>3</sup> S 76 + 146: H +5 mm \*\* Not equipped with an integrated vehicle mount for both vario3



## Systainer<sup>3</sup> M 112

Small and functional! Thanks to its low height, for example, it is an excellent way to store abrasive material. The Systainer<sup>3</sup> M 112 can be conveniently transported upright with its front handle.

### Systainer<sup>3</sup> M 112

- Light grey art n° 83000001
- Anthracite art n° 83000018

## DIMENSIONS

Outside in mm	Inside in mm	Weight	Carrying capacity	Inner volume	Pallet Pcs./H.
H* 105 x W 396 x D 296	H 71 x W 389.5 x D 275	1.40 kg	20 kg	7.7 l	128 / 183.7 cm

\*The outside dimensions are measured without feet: H + 7 mm

## COLOR

	Standard colors	Additional colors
Body with lid	1)  3)	4)  5)  6)  7)  8)  9)  10)
Lid handle	1)  3)	4)  5)  6)  7)  8)  9)  10)  11)  12)
Catch	2)  3)	1)  4)  5)  6)  7)  8)  9)  10)  11)  12)

1) RAL 7035, light grey      4) RAL 9004, black      7) RAL 3002, carmine red      10) RAL 6001, emerald green  
 2) HKS 43 K, signal blue      5) RAL 1007, daffodil yellow      8) RAL 5015, sky blue      11) HKS 54 K, signal green  
 3) RAL 7016, anthracite      6) RAL 2011, deep orange      9) RAL 5003, sapphire blue      12) RAL 9016, white

## Systainer<sup>3</sup> M 112 SETS



### Universal-Systainer<sup>3</sup> M 112

- Light grey art n° 83500009
- Anthracite art n° 83500010
- With lid insert, EPP, 5 mm and universal insert with 10 compartments



### Abrasive material Systainer<sup>3</sup> M 112

- Light grey art n° 83500013
- Anthracite art n° 83500014
- With insert for abrasives  
Ø 125 mm, 80 x 133 mm and Delta 100 x 150 mm

## LID INSERTS



**Lid insert M, EPP, 5 mm**  
• Art n° 83000044



**Lid foam M, vaulted**  
• Art n° 83000035  
(Industry customers\*)  
• Art n° 83570006  
(Dealers/end users\*\*)



**Office lid**  
• Art n° 83500069

## BOTTOM INSERTS



**Base foam M, soft, 25 mm**  
• Art n° 83000036  
(Industry customers\*)  
• Art n° 83570007  
(Dealers/end users\*\*)



**Pick & pluck foam M, rigid, 25 mm**  
• Art n° 83000038  
(Industry customers\*)  
• Art n° 83570009  
(Dealers/end users\*\*)

Perforated cubes, 15 x 15 mm,  
for quarrying out



**Base foam with cross cut-out**  
• Art n° 83000037  
(Industry customers\*)  
• Art n° 83570008  
(Dealers/end users\*\*)



**Universal insert with 10 compartments**  
• Art n° 83000052



**Insert for abrasives Ø 125 mm,  
80 x 133 mm and  
Delta 100 x 150 mm**  
• Art n° 83000056



## Systainer<sup>3</sup> M 137

Handy and mobile! The Systainer<sup>3</sup> M 137 can not only be perfectly integrated into a vehicle equipment, it is also easy to remove and transport using the front handle.

### Systainer<sup>3</sup> M 137

- Light grey art n° 83000002
- Anthracite art n° 83000019

## DIMENSIONS

Outside in mm	Inside in mm	Weight	Carrying capacity	Inner volume	Pallet Pcs. / H.
H* 130 x W 396 x D 296	H 96 x W 389.5 x D 275	1.50 kg	20 kg	10.4 l	104 / 184.7 cm

\*The outside dimensions are measured without feet: H + 7 mm

## COLORS

	Standard colors	Additional colors	
Body with lid	1)  3)	4)  5)  6)  7)  8)  9)  10)	
Lid handle	1)  3)	4)  5)  6)  7)  8)  9)  10)  11)  12)	
Catch	2)  3)	1)  4)  5)  6)  7)  8)  9)  10)  11)  12)	
1) RAL 7035, light grey	4) RAL 9004, black	7) RAL 3002, carmine red	10) RAL 6001, emerald green
2) HKS 43 K, signal blue	5) RAL 1007, daffodil yellow	8) RAL 5015, sky blue	11) HKS 54 K, signal green
3) RAL 7016, anthracite	6) RAL 2011, deep orange	9) RAL 5003, sapphire blue	12) RAL 9016, white

## Systainer<sup>3</sup> M 137 SETS



### Padded-Systainer<sup>3</sup> M 137

- Light grey art n° 83500015
- Anthracite art n° 83500016
- With base foam soft, 25 mm, base pick & pluck foam rigid, 25 mm and lid foam, vaulted



### Cordless drill Systainer<sup>3</sup> M 137

- Light grey art n° 83500011
- Anthracite art n° 83500012
- With insert for cordless drill and lid foam, vaulted

## LID INSERTS



**Lid insert M, EPP, 5 mm**

- Art n° 83000044



**Lid foam M, vaulted**

- Art n° 83000035  
(Industry customers\*)
- Art n° 83570006  
(Dealers/end users\*\*)



**Office lid**

- Art n° 83500069

## BOTTOM INSERTS



**Base foam M, soft, 25 mm**

- Art n° 83000036  
(Industry customers\*)
- Art n° 83570007  
(Dealers/end users\*\*)



**Pick & pluck foam M, rigid, 25 mm**

- Art n° 83000038  
(Industry customers\*)
- Art n° 83570009  
(Dealers/end users\*\*)

Perforated cubes, 15 x 15 mm,  
for quarrying out



**Base foam with cross cut-out**

- Art n° 83000037  
(Industry customers\*)
- Art n° 83570008  
(Dealers/end users\*\*)



**Insert for cordless drill**

- Art n° 83000053



## Systainer<sup>3</sup> M 187

With its compact dimensions, the Systainer<sup>3</sup> M 187 adapts to your individual equipment needs. The Systainer<sup>3</sup> M 187 is especially well suited for power tools or office materials. Upright carrying option included with the front handle.

### Systainer<sup>3</sup> M 187

- Light grey art n° 83000003
- Anthracite art n° 83000020

## DIMENSIONS

Outside in mm	Inside in mm	Weight	Carrying capacity	Inner volume	Pallet Pcs./H.
H* 180 x W 396 x D 296	H 146 x W 389.7 x D 275.2	1.69 kg	20 kg	15.9 l	72 / 177.7 cm

\*The outside dimensions are measured without feet: H + 7 mm

## COLORS

	Standard colors	Additional colors	
Body with lid	1)  3)	4)  5)  6)  7)  8)  9)  10)	
Lid handle	1)  3)	4)  5)  6)  7)  8)  9)  10)  11)  12)	
Catch	2)  3)	1)  4)  5)  6)  7)  8)  9)  10)  11)  12)	
1) RAL 7035, light grey	4) RAL 9004, black	7) RAL 3002, carmine red	10) RAL 6001, emerald green
2) HKS 43 K, signal blue	5) RAL 1007, daffodil yellow	8) RAL 5015, sky blue	11) HKS 54 K, signal green
3) RAL 7016, anthracite	6) RAL 2011, deep orange	9) RAL 5003, sapphire blue	12) RAL 9016, white

## Systainer<sup>3</sup> M 187 SETS



### Oscillator-Systainer<sup>3</sup> M 187

- Light grey art n° 83500017
- Anthracite art n° 83500018
- With insert for oscillator and lid foam, vaulted



### Angle grinder Systainer<sup>3</sup> M 187

- Light grey art n° 83500019
- Anthracite art n° 83500020
- With insert for angle grinders Ø 125 mm and lid foam, vaulted



## LID INSERTS



**Lid insert M, EPP, 5 mm**  
• Art n° 83000044



**Lid foam M, vaulted**  
• Art n° 83000035  
(Industry customers\*)  
• Art n° 83570006  
(Dealers/end users\*\*)



**Office lid**  
• Art n° 83500069

## BOTTOM INSERTS



**Base foam M, soft, 25 mm**  
• Art n° 83000036  
(Industry customers\*)  
• Art n° 83570007  
(Dealers/end users\*\*)



**Pick & pluck foam M, rigid, 25 mm**  
• Art n° 83000038  
(Industry customers\*)  
• Art n° 83570009  
(Dealers/end users\*\*)

Perforated cubes, 15 x 15 mm,  
for quarrying out



**Base foam with cross cut-out**  
• Art n° 83000037  
(Industry customers\*)  
• Art n° 83570008  
(Dealers/end users\*\*)



**Insert for angle grinder**  
Ø 125 mm  
• Art n° 83000054



**Insert for oscillator**  
• Art n° 83000055



**Foam for fixation for insert  
for oscillator**  
• Art n° 83500077



## Systainer<sup>3</sup> M 237

Optimal storage for tools or insulation for sensitive contents: that's the Systainer<sup>3</sup> M 237. The integrated pull-out aid makes it easier to remove the case from a shelf or vehicle.

### Systainer<sup>3</sup> M 237

- Light grey art n° 83000004
- Anthracite art n° 83000021

## DIMENSIONS

Outside in mm	Inside in mm	Weight	Carrying capacity	Inner volume	Pallet Pcs./H.
H* 230 x W 396 x D 296	H 196 x W 389.7 x D 275.2	1.89 kg	20 kg	21.4 l	56 / 176.7 cm

\*The outside dimensions are measured without feet: H + 7 mm

## COLORS

	Standard colors	Additional colors	
Body with lid			
Lid handle			
Catch			
1) RAL 7035, light grey	4) RAL 9004, black	7) RAL 3002, carmine red	10) RAL 6001, emerald green
2) HKS 43 K, signal blue	5) RAL 1007, daffodil yellow	8) RAL 5015, sky blue	11) HKS 54 K, signal green
3) RAL 7016, anthracite	6) RAL 2011, deep orange	9) RAL 5003, sapphire blue	12) RAL 9016, white

## Systainer<sup>3</sup> M 237 SETS



### Abrasive material Systainer<sup>3</sup> M 237

- Light grey art n° 83500023
- Anthracite art n° 83500024
- With insert for abrasives  
Ø 150 mm



### Insulated Systainer<sup>3</sup> M 237 EPP

- Light grey art n° 83500037
- Anthracite art n° 83500038
- With EPP insulating insert and insulating lid

## LID INSERTS



**Lid insert M, EPP, 5 mm**  
• Art n° 83000044



**Lid foam M, vaulted**  
• Art n° 83000035  
(Industry customers\*)  
• Art n° 83570006  
(Dealers/end users\*\*)



**Office lid**  
• Art n° 83500069

## BOTTOM INSERTS



**Base foam M, soft, 25 mm**  
• Art n° 83000036  
(Industry customers\*)  
• Art n° 83570007  
(Dealers/end users\*\*)



**Pick & pluck foam M, rigid, 25 mm**  
• Art n° 83000038  
(Industry customers\*)  
• Art n° 83570009  
(Dealers/end users\*\*)

Perforated cubes, 15 x 15 mm,  
for quarrying out



**Base foam with cross cut-out**  
• Art n° 83000037  
(Industry customers\*)  
• Art n° 83570008  
(Dealers/end users\*\*)



**Insert for abrasives**  
Ø 150 mm  
• Art n° 83000057



**Divider for Insulated Systainer<sup>3</sup>**  
• Art n° 83500066  
• Set of 2



**Set of 3 dividers**  
• Art n° 83500054



## Systainer<sup>3</sup> M 337

Flying high with the Systainer<sup>3</sup> M 337. With its impressive height, it offers lots of inside space for hand tools and tall materials. It is optimally suited for insulating cartridges, spray cans and sensitive contents.

### Systainer<sup>3</sup> M 337

- Light grey art n° 83000005
- Anthracite art n° 83000022

## DIMENSIONS

Outside in mm	Inside in mm	Weight	Carrying capacity	Inner volume	Pallet Pcs./H.
H* 330 x W 396 x D 296	H 296 x W 389.7 x D 275.2	2.35 kg	20 kg	32.4 l	40 / 180.7 cm

\*The outside dimensions are measured without feet: H + 7 mm

## COLORS

	Standard colors	Additional colors
Body with lid	1)  3)	4)  5)  6)  7)  8)  9)  10)
Lid handle	1)  3)	4)  5)  6)  7)  8)  9)  10)  11)  12)
Catch	2)  3)	1)  4)  5)  6)  7)  8)  9)  10)  11)  12)
	1) RAL 7035, light grey 2) HKS 43 K, signal blue 3) RAL 7016, anthracite	4) RAL 9004, black 5) RAL 1007, daffodil yellow 6) RAL 2011, deep orange 7) RAL 3002, carmine red 8) RAL 5015, sky blue 9) RAL 5003, sapphire blue 10) RAL 6001, emerald green 11) HKS 54 K, signal green 12) RAL 9016, white

## Systainer<sup>3</sup> M 337 SETS



### Cartridge-Systainer<sup>3</sup> M 337\*\*\*

- Light grey art n° 83500027
- Anthracite art n° 83500028
- With EPP cartridge insert



### Aerosol-Systainer<sup>3</sup> M 337\*\*\*\*

- Light grey art n° 83500031
- Anthracite art n° 83500032
- With EPP spray can insert



### Insulated Systainer<sup>3</sup> M 337 EPP

- Light grey art n° 83500039
- Anthracite art n° 83500040
- With EPP insulating insert and insulating lid

## LID INSERTS



**Lid insert M, EPP, 5 mm**  
• Art n° 83000044



**Lid foam M, vaulted**  
• Art n° 83000035  
(Industry customers\*)  
• Art n° 83570006  
(Dealers/end users\*\*)



**Office lid**  
• Art n° 83500069

## BOTTOM INSERTS



**Base foam M, soft, 25 mm**  
• Art n° 83000036  
(Industry customers\*)  
• Art n° 83570007  
(Dealers/end users\*\*)



**Pick & pluck foam M, rigid, 25 mm**  
• Art n° 83000038  
(Industry customers\*)  
• Art n° 83570009  
(Dealers/end users\*\*)

Perforated cubes, 15 x 15 mm,  
for quarrying out



**Base foam with cross cut-out**  
• Art n° 83000037  
(Industry customers\*)  
• Art n° 83570008  
(Dealers/end users\*\*)



**EPP cartridge insert\*\*\***  
• Art n° 83000046



**EPP spray can insert\*\*\*\***  
• Art n° 83000047



**Divider for Insulated Systerainer³**  
• Art n° 83500066  
• Set of 2



## Systainer<sup>3</sup> M 437

Tall, taller, Systainer<sup>3</sup> M 437. The tallest Systainer<sup>3</sup> offers plenty of space for large work materials and tools, and is optimally suited for insulating cartridges, spray cans and sensitive contents or packaging large objects.

### Systainer<sup>3</sup> M 437

































- Light grey art n° 83000006
- Anthracite art n° 83000023

## DIMENSIONS

Outside in mm	Inside in mm	Weight	Carrying capacity	Inner volume	Pallet Pcs./H.
H* 430 x W 396 x D 296	H 394 x W 389.7 x D 275.2	2.89 kg	20 kg	43.1 l	32 / 187.7 cm

\*The outside dimensions are measured without feet: H + 7 mm

## COLORS

	Standard colors	Additional colors	
Body with lid	 <sup>1)</sup>  <sup>3)</sup>	 <sup>4)</sup>  <sup>5)</sup>  <sup>6)</sup>  <sup>7)</sup>  <sup>8)</sup>  <sup>9)</sup>  <sup>10)</sup>	
Lid handle	 	        <sup>11)</sup>  <sup>12)</sup>	
Catch	 <sup>2)</sup> 	 <sup>1)</sup>         	
1) RAL 7035, light grey	4) RAL 9004, black	7) RAL 3002, carmine red	10) RAL 6001, emerald green
2) HKS 43 K, signal blue	5) RAL 1007, daffodil yellow	8) RAL 5015, sky blue	11) HKS 54 K, signal green
3) RAL 7016, anthracite	6) RAL 2011, deep orange	9) RAL 5003, sapphire blue	12) RAL 9016, white

## Systainer<sup>3</sup> M 437 SETS



### Cartridge-Systainer<sup>3</sup> M 437\*\*\*

- Light grey art n° 83500029
- Anthracite art n° 83500030
- With EPP cartridge insert



### Aerosol-Systainer<sup>3</sup> M 437\*\*\*\*

- Light grey art n° 83500033
- Anthracite art n° 83500034
- With EPP spray can insert



### Insulated Systainer<sup>3</sup> M 437 EPP

- Light grey art n° 83500041
- Anthracite art n° 83500042
- With EPP insulating insert and insulating lid

## LID INSERTS



**Lid insert M, EPP, 5 mm**  
• Art n° 83000044



**Lid foam M, vaulted**  
• Art n° 83000035  
(Industry customers\*)  
• Art n° 83570006  
(Dealers/end users\*\*)



**Office lid**  
• Art n° 83500069

## BOTTOM INSERTS



**Base foam M, soft, 25 mm**  
• Art n° 83000036  
(Industry customers\*)  
• Art n° 83570007  
(Dealers/end users\*\*)



**Pick & pluck foam M, rigid, 25 mm**  
• Art n° 83000038  
(Industry customers\*)  
• Art n° 83570009  
(Dealers/end users\*\*)

Perforated cubes, 15 x 15 mm,  
for quarrying out



**Base foam with cross cut-out**  
• Art n° 83000037  
(Industry customers\*)  
• Art n° 83570008  
(Dealers/end users\*\*)



**EPP cartridge insert\*\*\***  
• Art n° 83000046



**EPP spray can insert\*\*\*\***  
• Art n° 83000047

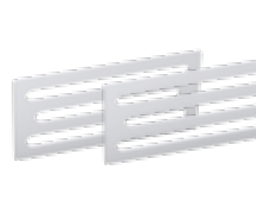

**Divider for Insulated Systainer<sup>3</sup>**  
• Art n° 83500066  
• Set of 2

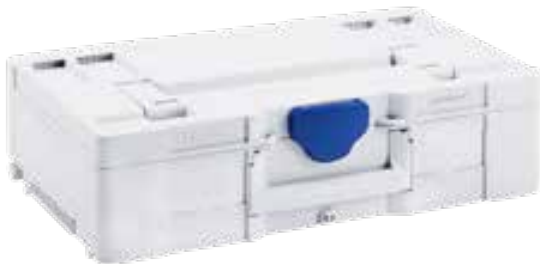

## Systainer<sup>3</sup> L 137

If you need a little extra storage space: Systainer<sup>3</sup> L 137. The Systainer<sup>3</sup> L 137 offers the best possible tool storage for your needs, as well as convenient carrying upright using the front handle.

### Systainer<sup>3</sup> L 137

- Light grey art n° 83000007
- Anthracite art n° 83000024

## DIMENSIONS

Outside in mm	Inside in mm	Weight	Carrying capacity	Inner volume	Pallet Pcs. / H.
H* 130 x W 508 x D 296	H 94 x W 501.5 x D 275.2	1.92 kg	20 kg	13.2 l	52 / 184.7 cm

\*The outside dimensions are measured without feet: H + 7 mm

## COLORS

	Standard colors	Additional colors	
Body with lid		Additional colors upon request	
Lid handle			
Catch			
1) RAL 7035, light grey	4) RAL 9004, black	7) RAL 3002, carmine red	10) RAL 6001, emerald green
2) HKS 43 K, signal blue	5) RAL 1007, daffodil yellow	8) RAL 5015, sky blue	11) HKS 54 K, signal green
3) RAL 7016, anthracite	6) RAL 2011, deep orange	9) RAL 5003, sapphire blue	12) RAL 9016, white

## Systainer<sup>3</sup> L 137 SETS



### Universal-Systainer<sup>3</sup> L 137

- Light grey art n° 83500043
- Anthracite art n° 83500044
- With lid insert, EPP, 5 mm and universal insert with 6 compartments



### Padded-Systainer<sup>3</sup> L 137

- Light grey art n° 83500045
- Anthracite art n° 83500046
- With base foam soft, 25 mm, base pick & pluck foam rigid, 25 mm, and lid foam, vaulted



## LID INSERTS



**Lid insert L, EPP, 5 mm**  
• Art n° 83000045



**Lid foam L, vaulted**  
• Art n° 83000040  
(Industry customers\*)  
• Art n° 83570010  
(Dealers/end users\*\*)



**Tool lid**  
• Art n° 83500070

## BOTTOM INSERTS



**Base foam L, soft, 25 mm**  
• Art n° 83000041  
(Industry customers\*)  
• Art n° 83570011  
(Dealers/end users\*\*)



**Pick & pluck foam L, rigid, 25 mm**  
• Art n° 83000043  
(Industry customers\*)  
• Art n° 83570012  
(Dealers/end users\*\*)

Perforated cubes, 15 x 15 mm,  
for quarrying out



**EPP base insert, 15 mm**  
• Art n° 83000042



**Universal insert L, with 6 compartments**  
• Art n° 83000058



## Systainer<sup>3</sup> L 187

Tools, angle grinders and much more, everything has its place in the Systainer<sup>3</sup> L 187. Carry upright or easily link to a tower; transportation is easy with the Systainer<sup>3</sup> L 187.

### Systainer<sup>3</sup> L 187

- Light grey art n° 83000008
- Anthracite art n° 83000025

## DIMENSIONS

Outside in mm	Inside in mm	Weight	Carrying capacity	Inner volume	Pallet Pcs./H.
H* 180 x W 508 x D 296	H 144 x W 501.7 x D 275.2	2.14 kg	20 kg	20.2 l	36 / 177.7 cm

\*The outside dimensions are measured without feet: H + 7 mm

## COLORS

	Standard colors	Additional colors	
Body with lid	1)  3)	Additional colors upon request	
Lid handle		4)  5)  6)  7)  8)  9)  10)  11)  12)	
Catch	2)	1)	
1) RAL 7035, light grey	4) RAL 9004, black	7) RAL 3002, carmine red	10) RAL 6001, emerald green
2) HKS 43 K, signal blue	5) RAL 1007, daffodil yellow	8) RAL 5015, sky blue	11) HKS 54 K, signal green
3) RAL 7016, anthracite	6) RAL 2011, deep orange	9) RAL 5003, sapphire blue	12) RAL 9016, white

## Systainer<sup>3</sup> L 187 SETS



### Tool-Systainer<sup>3</sup> L 187

- Light grey art n° 83500047
- Anthracite art n° 83500048
- With 2 tool lids and tool insert with dividers



## LID INSERTS



**Lid insert L, EPP, 5 mm**  
• Art n° 83000045



**Lid foam L, vaulted**  
• Art n° 83000040  
(Industry customers\*)  
• Art n° 83570010  
(Dealers/end users\*\*)



**Tool lid**  
• Art n° 83500070

## BOTTOM INSERTS



**Base foam L, soft, 25 mm**  
• Art n° 83000041  
(Industry customers\*)  
• Art n° 83570011  
(Dealers/end users\*\*)



**Pick & pluck foam L, rigid, 25 mm**  
• Art n° 83000043  
(Industry customers\*)  
• Art n° 83570012  
(Dealers/end users\*\*)

Perforated cubes, 15 x 15 mm,  
for quarrying out



**EPP base insert, 15 mm**  
• Art n° 83000042



**Divider-set for tool insert**  
• Art n° 83500154  
• For Tool-Systainer<sup>3</sup> L 187  
• 1 x short and 1 x long divider



## Systainer<sup>3</sup> L 237

The Systainer<sup>3</sup> L 237 offers additional space. Large equipment or utensils fit into this tool case. Just like all Systainer<sup>3</sup> L sizes, it can also be linked to the Systainer<sup>3</sup> M size and systainer<sup>®</sup> T-Loc.

### Systainer<sup>3</sup> L 237

- Light grey art n° 83000009
- Anthracite art n° 83000026

## DIMENSIONS

Outside in mm	Inside in mm	Weight	Carrying capacity	Inner volume	Pallet Pcs./H.
H* 230 x W 508 x D 296	H 194 x W 501.7 x D 275.2	2.38 kg	20 kg	27.4 l	28 / 176.7 cm

\*The outside dimensions are measured without feet: H + 7 mm

## COLORS

	Standard colors	Additional colors	
Body with lid	1)  3)	Additional colors upon request	
Lid handle		4)  5)  6)  7)  8)  9)  10)  11)  12)	
Catch	2)	1)	
1) RAL 7035, light grey	4) RAL 9004, black	7) RAL 3002, carmine red	10) RAL 6001, emerald green
2) HKS 43 K, signal blue	5) RAL 1007, daffodil yellow	8) RAL 5015, sky blue	11) HKS 54 K, signal green
3) RAL 7016, anthracite	6) RAL 2011, deep orange	9) RAL 5003, sapphire blue	12) RAL 9016, white

## LID INSERTS



**Lid insert L, EPP, 5 mm**  
• Art n° 83000045



**Lid foam L, vaulted**  
• Art n° 83000040  
(Industry customers\*)  
• Art n° 83570010  
(Dealers/end users\*\*)



**Tool lid**  
• Art n° 83500070

## BOTTOM INSERTS



**Base foam L, soft, 25 mm**  
• Art n° 83000041  
(Industry customers\*)  
• Art n° 83570011  
(Dealers/end users\*\*)



**Pick & pluck foam L, rigid, 25 mm**  
• Art n° 83000043  
(Industry customers\*)  
• Art n° 83570012  
(Dealers/end users\*\*)

Perforated cubes, 15 x 15 mm,  
for quarrying out



**EPP base insert, 15 mm**  
• Art n° 83000042



1)

## Systainer<sup>3</sup> XXL 237 + 337

Bigger, better, stronger! The Systainer<sup>3</sup> with plenty of space and volume. The essential choice for bulky items and large materials or tools: Systainer<sup>3</sup> XXL 237 and 337.

### Systainer<sup>3</sup> XXL 237 <sup>1)</sup>

- Light grey art n° 83000016
- Anthracite art n° 83000033

### Systainer<sup>3</sup> XXL 337 <sup>2)</sup>

- Light grey art n° 83000017
- Anthracite art n° 83000034



2)

## DIMENSIONS

### Systainer<sup>3</sup> XXL 237

Outside in mm	Inside in mm	Weight	Carrying capacity	Inner volume	Pallet Pcs./H.
H* 230 x W 792 x D 296	H 188 x W 786.5 x D 279.1	3.64 kg	40 kg	42.3 l	28 / 176.7 cm

### Systainer<sup>3</sup> XXL 337

Outside in mm	Inside in mm	Weight	Carrying capacity	Inner volume	Pallet Pcs./H.
H* 330 x W 792 x D 296	H 288 x W 786.1 x D 279.1	4.33 kg	40 kg	64.2 l	20 / 180.7 cm

\*The outside dimensions are measured without feet: H + 7 mm

## COLORS

	Standard colors	Additional colors	
Body with lid		Additional colors upon request	
Lid handle			
Catch			
1) RAL 7035, light grey	4) RAL 9004, black	7) RAL 3002, carmine red	10) RAL 6001, emerald green
2) HKS 43 K, signal blue	5) RAL 1007, daffodil yellow	8) RAL 5015, sky blue	11) HKS 54 K, signal green
3) RAL 7016, anthracite	6) RAL 2011, deep orange	9) RAL 5003, sapphire blue	12) RAL 9016, white

## LID INSERTS



### Lid foam XXL, vaulted

- Art n° 83000066 (Industry customers\*)
- Art n° 83570013 (Dealers/end users\*\*)

## BOTTOM INSERTS



### Base foam XXL, soft, 25 mm

- Art n° 83000067 (Industry customers\*)
- Art n° 83570014 (Dealers/end users\*\*)



### Pick & pluck foam XXL, rigid, 50 mm\*\*\*

- Art n° 83000068 (Industry customers\*)
- Art n° 83570015 (Dealers/end users\*\*)



### Mounting Plate

- Art n° 83500274
- incl. hook and loop fastener 3 m and fastening material



**Proven**  
T-Loc  
central controller



**Interfaces**  
to Systainer<sup>3</sup> M + L  
and systainer<sup>®</sup> T-Loc



**Secure**  
the Systainer<sup>3</sup>  
using an integrated  
latch (Theft Tag)



**Carry**  
the Systainer<sup>3</sup> by using the later-  
al integrated grip recess



**Transport**  
the case using the Systainer<sup>3</sup>  
CART "SYS-RB" roller board



**Label**  
the Systainer<sup>3</sup> with two slots  
for custom labeling





## Systainer<sup>3</sup> ORGANIZER M 89

For fans of structure: Small parts sorting for professionals. With Systainer<sup>3</sup> Organizer M 89, every small consumable material has its place and is clearly sorted. Already fitted with insert boxes or customized, it is your choice.

### Systainer<sup>3</sup> Organizer M 89

- Light grey art n° 83000010
- Anthracite art n° 83000027

## DIMENSIONS

Outside in mm	Inside in mm	Weight	Carrying capacity	Inner volume	Pallet Pcs./H.
H* 82 x W 396 x D 296	H 60 x W 389.5 x D 246.2	1.60 kg	20 kg	7.4 l	160 / 183.7 cm

\*The outside dimensions are measured without feet: H + 7 mm

## COLORS

	Standard colors	Additional colors	
Body without lid	1)  3)	Additional colors upon request	
Catch	2)	1)  4)  5)  6)  7)  8)  9)  10)  11)  12)	
1) RAL 7035, light grey	4) RAL 9004, black	7) RAL 3002, carmine red	10) RAL 6001, emerald green
2) HKS 43 K, signal blue	5) RAL 1007, daffodil yellow	8) RAL 5015, sky blue	11) HKS 54 K, signal green
3) RAL 7016, anthracite	6) RAL 2011, deep orange	9) RAL 5003, sapphire blue	12) RAL 9016, white

## Systainer<sup>3</sup> ORGANIZER M 89 SETS



### Systainer<sup>3</sup> Organizer M 89 with 22 insert boxes

- Light grey art n° 83500001
- Anthracite art n° 83500005
- Insert boxes:
  - 13 pcs. 50 x 50,
  - 8 pcs. 50 x 100,
  - 1 pc. 100 x 150



### Systainer<sup>3</sup> Organizer M 89 with 6 insert boxes

- Light grey art n° 83500002
- Anthracite art n° 83500006
- Insert boxes:
  - 1 pc. 50 x 50,
  - 1 pc. 50 x 100,
  - 3 pcs. 100 x 150,
  - 1 pc. 100 x 350



## BOTTOM INSERTS



### Insert box set 50 x 50

- Art n° 83500055
- Set of 10
- D 50 x W 50 x H 68 mm



### Insert box set 50 x 100

- Art n° 83500056
- Set of 10
- D 50 x W 100 x H 68 mm



### Insert box set 100 x 100

- Art n° 83500057
- Set of 6
- D 100 x W 100 x H 68 mm



### Insert box set 100 x 150

- Art n° 83500058
- Set of 6
- D 100 x W 150 x H 68 mm



### Insert box set 100 x 350

- Art n° 83500059
- Set of 2
- D 100 x W 350 x H 68 mm



### Insert box set 150 x 150

- Art n° 83500060
- Set of 6
- D 150 x W 150 x H 68 mm



### Insert box set 150 x 300

- Art n° 83500061
- Set of 2
- D 150 x W 300 x H 68 mm



## Systainer<sup>3</sup> ORGANIZER L 89

The Systainer<sup>3</sup> Organizer L 89 for even better sorting. The case also organizes a broad range of consumable materials like screws and dowels. Everything is clearly sorted, and the transparent lid allows you to keep your perspective, even with the lid closed.

### Systainer<sup>3</sup> Organizer L 89

- Light grey art n° 83000011
- Anthracite art n° 83000028

## DIMENSIONS

Outside in mm	Inside in mm	Weight	Carrying capacity	Inner volume	Pallet Pcs./H.
H* 82 x W 508 x D 296	H 60 x W 501.5 x D 278.5	1.99 kg	20 kg	9.7 l	80 / 183.7 cm

\*The outside dimensions are measured without feet: H + 7 mm

## COLORS

	Standard colors	Additional colors	
Body without lid	1)  3)	Additional colors upon request	
Catch	2)	1)  4)  5)  6)  7)  8)  9)  10)  11)  12)	
1) RAL 7035, light grey	4) RAL 9004, black	7) RAL 3002, carmine red	10) RAL 6001, emerald green
2) HKS 43 K, signal blue	5) RAL 1007, daffodil yellow	8) RAL 5015, sky blue	11) HKS 54 K, signal green
3) RAL 7016, anthracite	6) RAL 2011, deep orange	9) RAL 5003, sapphire blue	12) RAL 9016, white

## Systainer<sup>3</sup> ORGANIZER L 89 SETS



### Systainer<sup>3</sup> Organizer L 89 with 20 insert boxes

- Light grey art n° 83500003
- Anthracite art n° 83500007
- Insert boxes:
  - 10 pcs. 50 x 50,
  - 6 pcs. 50 x 100,
  - 2 pcs. 100 x 100,
  - 1 pc. 100 x 150,
  - 1 pc. 150 x 150



### Systainer<sup>3</sup> Organizer L 89 with 10 insert boxes

- Light grey art n° 83500004
- Anthracite art n° 83500008
- Insert boxes:
  - 1 pc. 50 x 50,
  - 4 pcs. 50 x 100,
  - 1 pc. 100 x 100,
  - 3 pcs. 100 x 150,
  - 1 pc. 100 x 350

## BOTTOM INSERTS



### Insert box set 50 x 50

- Art n° 83500055
- Set of 10
- D 50 x W 50 x H 68 mm



### Insert box set 50 x 100

- Art n° 83500056
- Set of 10
- D 50 x W 100 x H 68 mm



### Insert box set 100 x 100

- Art n° 83500057
- Set of 6
- D 100 x W 100 x H 68 mm



### Insert box set 100 x 150

- Art n° 83500058
- Set of 6
- D 100 x W 150 x H 68 mm



### Insert box set 100 x 350

- Art n° 83500059
- Set of 2
- D 100 x W 350 x H 68 mm



### Insert box set 150 x 150

- Art n° 83500060
- Set of 6
- D 150 x W 150 x H 68 mm



### Insert box set 150 x 300

- Art n° 83500061
- Set of 2
- D 150 x W 300 x H 68 mm



1)



2)



3)

## Systainer<sup>3</sup> TOOLBOX

Everything is ready to hand in the Systainer<sup>3</sup> ToolBox! The convertible version of the Systainer<sup>3</sup> system with plenty of storage capacity for tools, working material and accessories. Thanks to the movable carrying handle and the Systainer<sup>3</sup> closing catch, Systainer<sup>3</sup> can be linked with just one flick of the wrist. It can be connected to all Systainer<sup>3</sup> and systainer<sup>®</sup> T-Loc and integrated into van racking equipment, this makes the ToolBox the perfect companion at work.

### Systainer<sup>3</sup> ToolBox M 137 <sup>1)</sup>

- Light grey art n° 83000012
- Anthracite art n° 83000029

### Systainer<sup>3</sup> ToolBox M 237 <sup>2)</sup>

- Light grey art n° 83000013
- Anthracite art n° 83000030

### Systainer<sup>3</sup> ToolBox L 137 <sup>3)</sup>

- Light grey art n° 83000014
- Anthracite art n° 83000031

### Systainer<sup>3</sup> ToolBox L 237 <sup>4)</sup>

- Light grey art n° 83000015
- Anthracite art n° 83000032



4)

## DIMENSIONS

### Systainer<sup>3</sup> ToolBox M 137

Outside in mm	Inside in mm	Weight	Carrying capacity	Inner volume	Pallet Pcs./H.
H* 130 x W 396 x D 296	H 122 x W 357.8 x D 221	1.30 kg	20 kg	10.4 l	104 / 184.7 cm

### Systainer<sup>3</sup> ToolBox M 237

Outside in mm	Inside in mm	Weight	Carrying capacity	Inner volume	Pallet Pcs./H.
H* 230 x W 396 x D 296	H 222 x W 357.8 x D 221	1.70 kg	20 kg	21.4 l	56 / 176.7 cm

### Systainer<sup>3</sup> ToolBox L 137















Outside in mm	Inside in mm	Weight	Carrying capacity	Inner volume	Pallet Pcs./H.
H* 130 x W 508 x D 296	H 120 x W 461.1 x D 221	1.90 kg	20 kg	13.2 l	52 / 184.7 cm

### Systainer<sup>3</sup> ToolBox L 237

Outside in mm	Inside in mm	Weight	Carrying capacity	Inner volume	Pallet Pcs./H.
H* 230 x W 508 x D 296	H 220 x W 461.1 x D 221	2.40 kg	20 kg	27.4 l	28 / 176.7 cm

\*The outside dimensions are measured without feet: H + 7 mm

## COLORS

	Standard colors	Additional colors
Body with carrying handle	 1)  3)	Additional colors upon request
Catch	 2) 	 1)  4)  5)  6)  7)  8)  9)  10)  11)  12)
	1) RAL 7035, light grey 2) HKS 43 K, signal blue 3) RAL 7016, anthracite	4) RAL 9004, black 5) RAL 1007, daffodil yellow 6) RAL 2011, deep orange 7) RAL 3002, carmine red 8) RAL 5015, sky blue 9) RAL 5003, sapphire blue 10) RAL 6001, emerald green 11) HKS 54 K, signal green 12) RAL 9016, white

## BOTTOM INSERTS Systainer<sup>3</sup> M



### Base foam M, soft, 25 mm

- Art n° 83000036  
(Industry customers\*)
- Art n° 83570007  
(Dealers/end users\*\*)



### Pick & pluck foam M, rigid, 25 mm\*\*\*

- Art n° 83000038  
(Industry customers\*)
- Art n°. 83570009  
(Dealers/end users\*\*)



### Base foam with cross cut-out

- Art n° 83000037  
(Industry customers\*)
- Art n° 83570008  
(Dealers/end users\*\*)

## BOTTOM INSERTS Systainer<sup>3</sup> L



### Base foam M, soft, 25 mm

- Art n° 83000041  
(Industry customers\*)
- Art n° 83570011  
(Dealers/end users\*\*)



### Pick & pluck foam M, rigid, 25 mm\*\*\*

- Art n° 83000043  
(Industry customers\*)
- Art n° 83570012  
(Dealers/end users\*\*)

## GOOD TO KNOW

- Open Systainer<sup>3</sup> design provides optimal overview of the contents
- Hand tools and consumables easily at hand
- Can be carried comfortably thanks to the wide and moveable carrying handle
- Systainer<sup>3</sup> ToolBox comes in 4 different dimensions





1)



2)



3)

## Systainer<sup>3</sup> LID COMPARTMENT M

Keep everything sorted, easy to find, and right at hand! The Systainer<sup>3</sup> lid compartment M is ideal for power tools with accessories. See immediately what parts, drill bits, or jigsaw blades you have thanks to the transparent lid. Separators allow for flexible division and custom organization of the lid compartment. The Systainer<sup>3</sup> is a great way to store hand-held tools, power tools, accessories, small components or other work equipment.

### Systainer<sup>3</sup> lid compartment M 137 <sup>1)</sup>

- Light grey art n° 83000563
- Anthracite art n° 83000564

### Systainer<sup>3</sup> lid compartment M 187 <sup>2)</sup>

- Light grey art n° 83000561
- Anthracite art n° 83000562

### Systainer<sup>3</sup> lid compartment M 237 <sup>3)</sup>

- Light grey art n° 83000559
- Anthracite art n° 83000560

Incl. separators for variable division of the sections in the lid compartment:  
4 x long separators,  
10 x short separators,  
8 x connectors



## DIMENSIONS

### Systainer<sup>3</sup> lid compartment M 137

Outside in mm	Inside in mm	Weight	Carrying capacity	Inner volume	Pallet Pcs./H.
H* 130 x W 396 x D 296	H 96 x W 389.5 x D 275	1.70 kg	20 kg	10.4 l	104 / 184.7 cm

### Systainer<sup>3</sup> lid compartment M 187

Outside in mm	Inside in mm	Weight	Carrying capacity	Inner volume	Pallet Pcs./H.
H* 180 x W 396 x D 296	H 146 x W 389.7 x D 275.2	1.90 kg	20 kg	15.9 l	72 / 177.7 cm

### Systainer<sup>3</sup> lid compartment M 237

Outside in mm	Inside in mm	Weight	Carrying capacity	Inner volume	Pallet Pcs./H.
H* 230 x W 396 x D 296	H 196 x W 389.7 x D 275.2	2.10 kg	20 kg	21.4 l	56 / 176.7 cm

\*The outside dimensions are measured without feet: H + 7 mm

## COLORS

	Standard colors	Additional colors	
Body with lid		Additional colors upon request	
Lid handle			
Catch			
1) RAL 7035, light grey	4) RAL 9004, black	7) RAL 3002, carmine red	10) RAL 6001, emerald green
2) HKS 43 K, signal blue	5) RAL 1007, daffodil yellow	8) RAL 5015, sky blue	11) HKS 54 K, signal green
3) RAL 7016, anthracite	6) RAL 2011, deep orange	9) RAL 5003, sapphire blue	12) RAL 9016, white

## LID INSERTS



### Bit cassette

- Art n° 83000566
- for Systainer<sup>3</sup> lid compartment M, consisting of 4 removable bit mounts with magnetic holder of 6 bits each



### SDS cassette

- Art n° 83000565
- for Systainer<sup>3</sup> lid compartment M, for 7 SDS drill bits diameter: 1 x 12, 1 x 10, 1 x 8, 3 x 6, 1 x 5



### Lid foam M, vaulted

- Art n° 83000035 (Industry customers\*)
- Art n° 83570006 (Dealers/end users\*\*)

## BOTTOM INSERTS



### Base foam M, soft, 25 mm

- Art n° 83000036 (Industry customers\*)
- Art n° 83570007 (Dealers/end users\*\*)



### Pick & pluck foam M, rigid, 25 mm\*\*\*

- Art n° 83000038 (Industry customers\*)
- Art n° 83570009 (Dealers/end users\*\*)



### Base foam with cross cut-out

- Art n° 83000037 (Industry customers\*)
- Art n° 83570008 (Dealers/end users\*\*)

## BOTTOM INSERTS Systainer<sup>3</sup> LID COMPARTMENT M 137



### Insert for cordless drill

- Art n° 83000053

## BOTTOM INSERTS Systainer<sup>3</sup> LID COMPARTMENT M 187



### Insert for angle grinder

Ø 125 mm

- Art n° 83000054



### Insert for oscillator

- Art n° 83000055



### Foam for fixation for insert for oscillator

- Art n° 83500077

## BOTTOM INSERTS Systainer<sup>3</sup> LID COMPARTMENT M 237



### Set of 3 dividers

- Art n° 83500054



## Systainer<sup>3</sup> COMBI M

The perfect combination of systainer® and integrated drawer brings together what belongs together: large tools, sensitive equipment and small accessories neatly organised in a practical case system. The combined solution for the workshop and construction site is available in two different sizes.



1)

### Systainer<sup>3</sup> Combi M 287 <sup>1)</sup>

- Light grey art n° 83000868
- Anthracite art n° 83000869



2)

### Systainer<sup>3</sup> Combi M 337 <sup>2)</sup>

- Light grey art n° 83000870
- Anthracite art n° 83000871

Incl. 2 dividers



## DIMENSIONS

### Systainer<sup>3</sup> Combi M 287

Outside in mm	Inside in mm	Weight	Carrying capacity	Inner volume	Pallet Pcs. / H.
H* 280 x W 396 x D 296	H 140 x W 389 x D 287	3.56 kg	20 kg	–	48 / 183.7 cm
Drawer	H 66 x W 343 x D 271	–	–	–	

### Systainer<sup>3</sup> Combi M 337

Outside in mm	Inside in mm	Weight	Carrying capacity	Inner volume	Pallet Pcs. / H.
H* 330 x W 396 x D 296	H 190 x W 389 x D 287	3.72 kg	20 kg	–	40 / 180.7 cm
Drawer	H 66 x W 343 x D 271	–	–	–	

\*The outside dimensions are measured without feet: H + 7 mm

## COLORS

	Standard colors	Additional colors	
Body with lid		Additional colors upon request	
Lid handle			
Catch			
1) RAL 7035, light grey	4) RAL 9004, black	7) RAL 3002, carmine red	10) RAL 6001, emerald green
2) HKS 43 K, signal blue	5) RAL 1007, daffodil yellow	8) RAL 5015, sky blue	11) HKS 54 K, signal green
3) RAL 7016, anthracite	6) RAL 2011, deep orange	9) RAL 5003, sapphire blue	12) RAL 9016, white



## LID INSERTS



**Lid insert M, EPP, 5 mm**

- Art n° 83000044



**Lid foam M, vaulted**

- Art n° 83000035  
(Industry customers\*)
- Art n° 83570006  
(Dealers/end users\*\*)



**Office lid**

- Art n° 83500069

## BOTTOM INSERTS



**Base foam M, soft, 25 mm**

- Art n° 83000036  
(Industry customers\*)
- Art n° 83570007  
(Dealers/end users\*\*)



**Pick & pluck foam M, rigid, 25 mm\*\*\***

- Art n° 83000038  
(Industry customers\*)
- Art n° 83570009  
(Dealers/end users\*\*)



**Base foam with cross cut-out**

- Art n° 83000037  
(Industry customers\*)
- Art n° 83570008  
(Dealers/end users\*\*)



**Insert box set 50 x 50**

- Art n° 83500055
- Set of 10  
D 50 x W 50 x H 68 mm



**Insert box set 50 x 100**

- Art n° 83500056
- Set of 10  
D 50 x W 100 x H 68 mm



**Insert box set 100 x 100**

- Art n° 83500057
- Set of 6  
D 100 x W 100 x H 68 mm



**Insert box set 100 x 150**

- Art n° 83500058
- Set of 6  
D 100 x W 150 x H 68 mm

## BOTTOM INSERTS Systainer<sup>3</sup> COMBI M 287



**Insert for cordless drill**

- Art n° 83000053



**Insert for angle grinder  
Ø 125 mm**

- Art n° 83000054



**Insert for oscillator**

- Art n° 83000055



**Divider Systainer<sup>3</sup>, set of 3**

- Art n° 83000880

## BOTTOM INSERTS Systainer<sup>3</sup> COMBI M 337



**Insert for abrasives  
Ø 150 mm**

- Art n° 83000057



**Divider Systainer<sup>3</sup>, set of 3**

- Art n° 83000880



1)

## Systainer<sup>3</sup> SORTAINER M



The Systainer<sup>3</sup> Sortainer not only offers space for countless small parts up to large packaging and loading devices, but also ensures optimum organization and flexibility in use with its drawer dividers and insert boxes. Available in two versions, the organizational system minimizes wasted time searching for missing parts and maximizes efficiency.

### Systainer<sup>3</sup> Sortainer/2 M 337 <sup>1)</sup>

- Incl. 2 dividers
- Light grey art n° 83000872
- Anthracite art n° 83000873

### Systainer<sup>3</sup> Sortainer/3 M 337 <sup>2)</sup>

- Incl. 2 dividers per drawer
- Light grey art n° 83000874
- Anthracite art n° 83000875



2)



## DIMENSIONS

### Systainer<sup>3</sup> Sortainer/2 M 337

























Outside in mm	Inside in mm	Weight	Carrying capacity	Inner volume	Pallet Pcs. / H.
H* 330 x W 396 x D 296	–	5.18 kg	30 kg	–	40 / 180.7 cm
Small drawer	H 66 x W 343 x D 271	–	–	–	–
High drawer	H 158 x W 343 x D 261	–	–	–	–

### Systainer<sup>3</sup> Sortainer/3 M 337

Outside in mm	Inside in mm	Weight	Carrying capacity	Inner volume	Pallet Pcs. / H.
H* 330 x W 396 x D 296	–	6.22 kg	30 kg	–	40 / 180.7 cm
Drawer	H 66 x W 343 x D 271	–	–	–	–

\*The outside dimensions are measured without feet: H + 7 mm

## COLORS

	Standard colors	Additional colors	
Body with lid	 1)  3)	Additional colors upon request	
Lid handle	 	 4)  5)  6)  7)  8)  9)  10)  11)  12)	
Catch	 2) 	 1)         	
1) RAL 7035, light grey	4) RAL 9004, black	7) RAL 3002, carmine red	10) RAL 6001, emerald green
2) HKS 43 K, signal blue	5) RAL 1007, daffodil yellow	8) RAL 5015, sky blue	11) HKS 54 K, signal green
3) RAL 7016, anthracite	6) RAL 2011, deep orange	9) RAL 5003, sapphire blue	12) RAL 9016, white

## BOTTOM INSERTS SMALL DRAWER



### Insert box set 50 x 50

- Art n° 83500055
- Set of 10
- D 50 x W 50 x H 68 mm



### Insert box set 50 x 100

- Art n° 83500056
- Set of 10
- D 50 x W 100 x H 68 mm



### Insert box set 100 x 100

- Art n° 83500057
- Set of 6
- D 100 x W 100 x H 68 mm



### Insert box set 100 x 150

- Art n° 83500058
- Set of 6
- D 100 x W 150 x H 68 mm



### Divider Systainer<sup>3</sup>, set of 3

- Art n° 83000880



1)

## Systainer<sup>3</sup> RACK M

The perfect rack for the construction site, workshop and when on the road. The Systainer<sup>3</sup> Rack extends the systainer<sup>®</sup> range with a practical storage solution for a total of six Systainer<sup>3</sup> S 76, ensuring clear, flexible and uniquely mobile sorting of small parts in the field.

### Systainer<sup>3</sup> Rack/0 M 337 <sup>1)</sup>

- Light grey art n° 83000876
- Anthracite art n° 83000877

### Systainer<sup>3</sup> Rack/6 M 337 <sup>2)</sup>

- Incl. 6 x Systainer<sup>3</sup> S 76 (incl. 1 x divider large, 4 x divider small)
- Light grey art n° 83000878
- Anthracite art n° 83000879



2)



## DIMENSIONS

### Systainer<sup>3</sup> Rack/0 M 337

Outside in mm	Inside in mm	Weight	Carrying capacity	Inner volume	Pallet Pcs. / H.
H* 330 x W 396 x D 296	–	4.06 kg	–	–	40 / 180.7 cm

### Systainer<sup>3</sup> Rack/6 M 337

Outside in mm	Inside in mm	Weight	Carrying capacity	Inner volume	Pallet Pcs. / H.
H* 330 x W 396 x D 296	–	7.05 kg	20 kg	–	40 / 180.7 cm

\*The outside dimensions are measured without feet: H + 7 mm

## COLORS

	Standard colors	Additional colors	
Body with lid		Additional colors upon request	
Lid handle			
Catch			
1) RAL 7035, light grey	4) RAL 9004, black	7) RAL 3002, carmine red	10) RAL 6001, emerald green
2) HKS 43 K, signal blue	5) RAL 1007, daffodil yellow	8) RAL 5015, sky blue	11) HKS 54 K, signal green
3) RAL 7016, anthracite	6) RAL 2011, deep orange	9) RAL 5003, sapphire blue	12) RAL 9016, white



#### Accessible

Whether linked in the systainer® tower or stowed away in the vehicle – the shelving system allows unrestricted access to the contents of the integrated Systainer® S 76.



#### Organized

Maximum overview for up to six individually equipped Systainer® S 76.



#### Purpose-orientated

Designed to hold up to six Systainer® S 76. A practical push mechanism makes dispensing a breeze.



#### Linkable

Systainer® Kompakt catch for simple connecting and linking with just a flick of the wrist.



#### Mobile

Can be integrated directly into both vario3 van racking systems. The locking system of the Systainer® Rack enables safe transport of the integrated Systainer® S 76 in a van, on a cart or by hand.



#### Compatible

Systainer® Rack can be combined with Systainer®, systainer® T-Loc and systainer® Classic-Line.



1)



2)

## Systainer<sup>3</sup> S 76

Despite its small size, the Systainer<sup>3</sup> S 76 is a handy space saver. With a variety of practical inserts, Systainer<sup>3</sup> S 76 is ideal for stowing small parts of all kinds. The best part: up to six Systainer<sup>3</sup> S 76 can be integrated into the specially designed Systainer<sup>3</sup> Rack M 337.

### Systainer<sup>3</sup> S 76 1)

- Light grey art n° 83000932
- Anthracite art n° 83000933

### Systainer<sup>3</sup> S 76, lid transparent 2)

- Light grey art n° 83000934



Systainer<sup>3</sup> Rack M

## DIMENSIONS

### Systainer<sup>3</sup> S 76

Outside in mm	Inside in mm	Weight	Carrying capacity	Inner volume	Pallet Pcs. / H.
H* 71 x W 265 x D 171	H 67 x W 258 x D 164	0.43 kg	5 kg	3.2 l	400 / 200 cm

### Systainer<sup>3</sup> S 76, transparent lid

Outside in mm	Inside in mm	Weight	Carrying capacity	Inner volume	Pallet Pcs. / H.
H* 71 x W 265 x D 171	H 67 x W 258 x D 164	0.43 kg	5 kg	3.2 l	400 / 200 cm

\*The outside dimensions are measured without feet: H + 5 mm

## COLORS

### Systainer<sup>3</sup> S 76

	Standard colors	Additional colors
Body with lid		Additional colors upon request
Lid handle		Additional colors upon request
Catch		

### Systainer<sup>3</sup> S 76, lid transparent

	Standard colors	Additional colors
Body with lid		Additional colors upon request
Lid handle		Additional colors upon request
Catch		

- 1) RAL 7035, light grey  
2) HKS 43 K, signal blue  
3) RAL 7016, anthracite

- 4) RAL 9004, black  
5) RAL 1007, daffodil yellow  
6) RAL 2011, deep orange

- 7) RAL 3002, carmine red  
8) RAL 5015, sky blue  
9) RAL 5003, sapphire blue

- 10) RAL 6001, emerald green  
11) HKS 54 K, signal green  
12) RAL 9016, white

## Systainer<sup>3</sup> S 76 SETS



### Universal-Systainer<sup>3</sup> S 76

- Light grey art n° 83500910
- Anthracite art n° 83500911
- With lid insert S, EPP and universal insert S



### Systainer<sup>3</sup> S 76 with dividers

- Light grey art n° 83000891
- Anthracite art n° 83000892
- Incl. 1 x divider large, 4 x divider small



### Universal-Systainer<sup>3</sup> S 76, transparent lid

- Light grey art n° 83500912
- With transparent cover and universal insert S



### Systainer<sup>3</sup> S 76, transparent lid with dividers

- Light grey art n° 83000893
- Incl. 1 x divider large, 4 x divider small

## LID INSERTS



### Lid insert S, EPP

- Art n° 83000911



### Lid foam S, vaulted

- Art n° 83000917 (Industry customers\*)
- Art n° 83500908 (Dealers/end users\*\*)



### Transparent cover

- Art n° 83500890
- For Systainer<sup>3</sup> S 76, transparent lid
- Incl. fastening materials

## BOTTOM INSERTS



### Base foam S, vaulted

- Art n° 83000916 (Industry customers\*)
- Art n° 83500907 (Dealers/end users\*\*)



### Pick & pluck foam S, soft, 40 mm

- Art n° 83000918 (Industry customers\*)
- Art n° 83500909 (Dealers/end users\*\*)

Perforated cubes, 10 x 10 mm, for quarrying out



### Universal insert S

- Art n° 83000867
- 8 compartments



## Systainer<sup>3</sup> S 147



The Systainer<sup>3</sup> S 147 is a real space saver despite its handy size. The latest generation of MINI-systemer<sup>®</sup> T-Loc can be fitted with a variety of practical inserts and is therefore ideal for stowing small parts of all kinds.

### Systainer<sup>3</sup> S 147

- Light grey art n° 83000894
- Anthracite art n° 83000895

## DIMENSIONS

Outside in mm	Inside in mm	Weight	Carrying capacity	Inner volume	Pallet Pcs./H.
H* 142 x W 265 x D 171	H 138 x W 258 x D 164	0.58 kg	5 kg	5.8 l	192 / 195 cm

\*The outside dimensions are measured without feet: H + 5 mm

## COLORS

	Standard colors	Additional colors	
Body with lid		Additional colors upon request	
Lid handle		Additional colors upon request	
Catch			
1) RAL 7035, light grey	4) RAL 9004, black	7) RAL 3002, carmine red	10) RAL 6001, emerald green
2) HKS 43 K, signal blue	5) RAL 1007, daffodil yellow	8) RAL 5015, sky blue	11) HKS 54 K, signal green
3) RAL 7016, anthracite	6) RAL 2011, deep orange	9) RAL 5003, sapphire blue	12) RAL 9016, white



## LID INSERTS



**Lid insert S, EPP**  
• Art n° 83000911



**Lid foam S, vaulted**  
• Art n° 83000917  
(Industry customers\*)  
• Art n° 83500908  
(Dealers/end users\*\*)

## BOTTOM INSERTS



**Base foam S, vaulted**  
• Art n° 83000916  
(Industry customers\*)  
• Art n° 83500907  
(Dealers/end users\*\*)



**Pick & pluck foam S, soft, 40 mm**  
• Art n° 83000918  
(Industry customers\*)  
• Art n° 83500909  
(Dealers/end users\*\*)

Perforated cubes, 10 x 10 mm,  
for quarrying out



## Systemer<sup>3</sup> TOOLBAG M



Flexible organization meets intelligent design. The robust, convertible textile bag is a real master of transformation, individuality guaranteed. In just a few simple steps, it transforms from a bag into a perfectly organized storage system. The soft grip carrying handle and ergonomic shoulder strap ensure back-friendly, safe transport. Fully compatible with the entire systemer<sup>®</sup> family and bott van racking equipment racking system.

### Systemer<sup>3</sup> ToolBag M

- Material: Polyester (D600 PES), Anthracite
- Available only in one size and version
- Art n°83000619

Included in the scope of supply:

- 2 x 12-Pocket Tool Insert
- 2 x 4-Pocket Tool Insert
- 1 x Universal Bag
- 1 x ToolBag Carrying Strap



Systemer<sup>3</sup> ToolBag M



12-Pocket Tool Insert



4-Pocket Tool Insert



Universal Bag



ToolBag Carrying Strap

## DIMENSIONS

### Systemer<sup>3</sup> ToolBag M

Outside in mm	Inside in mm	Weight	Carrying capacity	Inner volume	Pallet Pcs. /H.
H* 359 x W 396 x D 296		3.68 kg	20 kg		24 / 168.4 cm

\*The outside dimensions are measured without feet: H + 7 mm



## ACCESSORIES\*



### 12-Pocket and 4-Pocket Tool Insert

The Tool Insert is a practical accessory included with the Systainer<sup>3</sup> ToolBag M. It can also be purchased as an add-on accessory. These inserts can be prepared for different jobs and easily fastened to the ToolBag in a matter of seconds with Velcro. The 4-Pocket Tool Insert can hold up to 4 hand tools, or the 12-Pocket Tool Insert can hold up to 12 hand tools such as pliers, hammers or screwdrivers such as pliers, hammers or screwdrivers can be stored and sorted in the loops provided.

#### 12-Pocket Tool Insert

- Art n° 83000616
- for Systainer<sup>3</sup> ToolBag M
- Base Material: Polyester (D600 PES), Anthracite
- with Velcro
- Outside H 60 x W 370 x D 190 mm
- Weight 0.14 kg

#### 4-Pocket Tool Insert

- Art n° 83000617
- for Systainer<sup>3</sup> ToolBag M
- Base Material: Polyester (D600 PES), Anthracite
- with Velcro
- Outside H 35 x W 370 x D 190 mm
- Weight 0.12 kg



### Universal Bag

The Universal Bag can also be purchased as an additional extension. This Bag can quickly and easily be attached or replaced in the ToolBag with Velcro.

- Art n° 83000792
- for Systainer<sup>3</sup> ToolBag M
- Base Material: Polyester (D600 PES), Anthracite
- with Velcro
- Outside H 60 x W 110 x D 275 mm
- Weight 0.04 kg



### ToolBag Carrying Strap

The Carrying Strap can also be purchased as an add-on accessory. The adjustable carrying strap allows back-friendly transport of the ToolBag with a shoulder pad to relieve stress on the shoulder while carrying.

- Art n° 83000793
- for Systainer<sup>3</sup> ToolBag M
- Base Material: Polyester (D600 PES), Anthracite
- with Self-Closing Triangle Hook
- Length 1,050-1,500 mm
- Weight 0.12 kg



## systainer® STORAGE-BOX

The easily removable systainer® Tool- and Storage-Boxes are the ideal companions for flexibility and mobility everywhere.



### systainer® Storage-Box

- Light grey art n° 80101490
- Anthracite art n° 80101491
- With removable insert-boxes (2 x small, 2 x medium, 1 x big)



## DIMENSIONS

Outside in mm	Inside in mm	Weight	Pallet Pcs. / H.
H* 160 x W 396 x D 296 Height with handle*: 233 mm	–	2.50 kg	88 / 196 cm

\*The outside dimensions are measured without feet: H + 7 mm

## COLORS

	Standard colors	Additional colors	
Body and handle	1)  3)		
Catches	2)  3)	1)  4)  5)  7)  8)  9)  10)  11)  12)	
1) RAL 7035, light grey	4) RAL 9004, black	7) RAL 3002, carmine red	10) RAL 6001, emerald green
2) HKS 43 K, signal blue	5) RAL 1007, daffodil yellow	8) RAL 5015, sky blue	11) HKS 54 K, signal green
3) RAL 7016, anthracite	6) RAL 2011, deep orange	9) RAL 5003, sapphire blue	12) RAL 9016, white

## BOTTOM INSERTS



### Insert-box small

for systainer® Storage-Box

- Light grey art n° 80101555
- Outside dimensions:  
D 60 x W 60 x H 71 mm



### Insert-box medium

for systainer® Storage-Box

- Light grey art n° 80101556
- Outside dimensions:  
D 60 x W 120 x H 71 mm

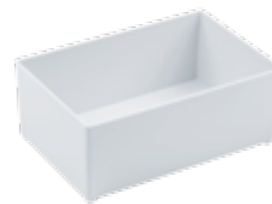

### Insert-box big

for systainer® Storage-Box

- Light grey art n° 80101557
- Outside dimensions:  
D 120 x W 180 x H 71 mm

## GOOD TO KNOW

- Excellent organisation of small parts with removable insert boxes
- Individual and flexible equipment
- Clear order of small parts
- Everything, from small parts to hand tools, always ready at hand





## INDIVIDUALIZATION

Whether you choose outside labelling for quick recognition of the contents, or our labelling system for the inside of the systainer® – there are various easy and uncomplicated ways to individualise your systainer®.

## KENNZEICHNUNG



### Label set for Systainer<sup>3</sup> Organizer insert boxes

- Small Set art n° 83500051
- Consisting of 30 paper labels and 12 transparent plug-in labels
- Large Set art n° 83500052
- Consisting of 60 paper labels and 25 transparent plug-in labels



### Label set for Systainer<sup>3</sup>

- Art n° 80500043
- Consisting of 20 transparent plug-in cards and 2 label sheets of 10 paper cards each
- For systainer® T-Loc I-V, systainer® T-Loc „SYS-Combi II + III“, Sortainer T-Loc „SYS-Sort IV/3“, Drawer „SYS-AZ“

Printing, adhesive labels, or plug-in card printing on requests – we will be glad to advise you about the countless possibilities.



## SAFETY

---



### Pull-tight seal

- Art n° 83500325
  - 50 pieces
  - For Systainer<sup>3</sup> M, L, XXL, Organizer, Systainer<sup>3</sup> lid compartment M, Systainer<sup>3</sup> Combi M, Systainer<sup>3</sup> S
- 

## SYSTEMER<sup>3</sup> XXS

---



### Systainer<sup>3</sup> XXS 33

- Light grey art n° 83000089
  - Outside dimensions: H 31.3 x W 105 x D 66 mm
  - Inside dimensions: H 23 x W 102 x D 59 mm
  - Weight: 0.04 kg
- 



### Insert for bits

- Art n° 83000279
  - Insert for up to 18 bits and one bit holder
-

## FLEXIBLE AT ALL TIMES

The working environment is changing and flexible work times are today as much a part of the daily routine as flexible application sites. In our "Mobile Work" section you will find innovative systemer<sup>®</sup> solutions with which you can work any time, anywhere. Freedom all around!

### MOBILE WORK



#### Mobile Workshop MW 1000 Basic

- Black/light grey/aluminium art n° 80102241
- Incl. 1 x drawer SYS-AZ-MW 1000
- Dimensions: L 641 x W 600 x H 1076 mm
- Work surface: 445 x 363 mm
- Working height: 900 mm
- Total load: 100 kg
- Weight: 19 kg



#### Mobile Workshop MW 1000

- Black/light grey/aluminium art n° 80591031
- Incl. 1 x drawer SYS-AZ-MW 1000 and table TSB/1-MW 1000
- Dimensions: L 641 x W 600 x H 1076 mm
- Work surface: 445 x 363 mm plus table TSB/1-MW 1000: 970 x 445 mm
- Working height: 900 mm
- Total load: 100 kg
- Weight: 31.2 kg



#### Drawer SYS-AZ-MW 1000

- Black/light grey art n° 80102243
- Dimensions: L 493 x W 373 x H 118 mm
- Total Load: 20 kg (assembled)
- Weight: 3.2 kg



#### Table TSB/1-MW 1000

- Aluminium/MDF art n° 80102244
- Dimensions: L 1045 x W 500 x H 74 mm
- Work surface: 970 x 445 mm
- Working height: 900 mm
- Total load: 100 kg
- Weight: 12.2 kg



## MOBILE WORK



### Systainer³ CART "SYS-RB"

- Light grey/blue art n° 83500064
- Anthracite art n° 83500065
- For Systainer³ M, L, XXL, Systainer³ Organizer M + L, Systainer³ lid compartment M, Systainer³ ToolBox M + L, MIDI-systainer® T-Loc II + III, systainer® T-Loc I - V, „SYS-Combi II + III“, Sortainer T-Loc „SYS-Sort IV / 3“, systainer® Tool-Box 1 + 2, and systainer® Storage-Box
- Even surface for the transport of various objects, integrated vehicle mount for bott vario3 vehicle equipment, four recessed grips on the sides for simple carrying, four swivel castors, two of them with brake function, big wheels (diameter: 100 mm) and wheel bases for optimal running
- Mount for tie-down straps
- Dimensions: H 159 x W 508 x D 396 mm
- Carrying capacity: 100 kg
- Net weight: 2.94 kg



### Caster "SYS-CART"

- Anthracite art n° 80600421
- For Systainer³ M, Systainer³ Organizer M, Systainer³ lid compartment M, Systainer³ ToolBox M, systainer® T-Loc, Classic-Line I-V, systainer® T-Loc „SYS-Combi II + III“, Sortainer T-Loc „SYS-Sort IV / 3“, Drawer-systainer®, Rack-systainer® IV, systainer® Tool-Box 1 + 2 and systainer® Storage-Box
- Four swivel castors, two of them with brake function
- Big wheels (diameter: 100 mm) and wheel bases for optimal running, recessed grips on the sides and through holes for U-lock
- Dimensions: H 157 x W 519 x D 365 mm
- Carrying capacity: 100 kg
- Net weight: 3.1 kg



### Transport trolley "SYS-Roll"

- Black/light grey art n° 80101699
- Comfortable transport of Systainer³ M, Systainer³ Organizer M, Systainer³ lid compartment M, Systainer³ ToolBox M, systainer® T-Loc and Classic Line I - V, systainer® T-Loc „SYS-Combi II + III“, Sortainer T-Loc „SYS-Sort IV / 3“, Drawer-systainer®, Rack-systainer® IV, systainer® Tool-Box 1 + 2 and systainer® Storage-Box
- Roll board and sack barrow function
- Easy transportation up and down steps due to extra large wheels
- Rotating and lockable front wheels
- Integrated drawer for storing small parts
- Variably adjustable safety belt included
- Wheels-Ø front: 75 mm
- Wheels-Ø back: 200 mm
- Dimensions: H 1,100 x W 600 x D 440 mm
- Weight: 9.4 kg
- Carrying capacity: 100 kg
- Carrying capacity drawer: 5 kg

### MOBILE WORK



#### Transport trolley "MAXI-TRAPO"

- Light grey/blue art n° 83570001
- For Systainer<sup>3</sup> M, L, XXL, Systainer<sup>3</sup> ToolBox M + L, Systainer<sup>3</sup> lid compartment M, Systainer<sup>3</sup> Organizer M + L, systainer<sup>®</sup> I - V, MIDI-systainer<sup>®</sup> T-Loc II + III, systainer<sup>®</sup> T-Loc „SYS-Combi II + III“, Sortainer T-Loc „SYS-Sort IV / 3“, Drawer-systainer<sup>®</sup>, Rack-systainer<sup>®</sup> IV, MAXI-systainer<sup>®</sup> II + III, systainer<sup>®</sup> Tool-Box 1 + 2 and systainer<sup>®</sup> Storage-Box
- With foldable carrier frame (L 425 x W 280 mm)
- Light running wheels with wheel covers and curved handle for a comfortable use even when it is heavily loaded
- Carrying capacity: 150 kg
- Net weight: 12 kg
- Height: 1,100 mm



#### Safety strap for "MAXI-TRAPO"

- Blue/black, length: 1500 mm art n° 83570000
- Blue/black, length: 2500 mm art n° 83570154
- To be clipped on the frame work



#### Carrying strap

- Blue/black art n° 83570002
- For the fixation on the handle
- For Systainer<sup>3</sup> M, L, XXL, Systainer<sup>3</sup> lid compartment M, Systainer<sup>3</sup> ToolBox M + L, systainer<sup>®</sup> T-Loc „SYS-Combi II + III“, Sortainer T-Loc „SYS-Sort IV / 3“, Drawer-systainer<sup>®</sup>, Rack-systainer<sup>®</sup> IV, MAXI-systainer<sup>®</sup> II + III, systainer<sup>®</sup> Tool-Box 1 + 2 and systainer<sup>®</sup> Storage-Box
- With shoulder pad and adjustable strap

## LITTLE HELPERS – BIG RESULTS

Our developers and product managers are working day in day out on new ideas and innovations for every greater user friendliness. It is often the little useful accessories which provide the greatest services.

### STATIONARY WORK



#### Systainer³ BASE – wall/base support

- Light grey/blue art n° 83500067
- Anthracite art n° 83500068
- For Systainer³ M, L, XXL, Systainer³ Organizer M + L, Systainer³ lid compartment M, Systainer³ ToolBox M + L
- Delivery without fastening materials!
- Dimensions: H 48 x W 508 x D 396 mm
- Net weight: 1.59 kg



#### Wall/base support "SYS-CART Base"

- Light grey/blue art n° 80590551
- For Systainer³ M, Systainer³ lid compartment M, Systainer³ ToolBox M and systainer® Storage-Box
- 4 recesses for the fixation with fastening (Delivery without fastening!)
- Dimensions: H 46 x W 519 x D 365 mm
- Net weight: 1.55 kg



#### Drawer "SYS-AZ"

- Individual light grey art n° 80101664
- Set of 5 light grey art n° 80590641
- Pull-out shelf, suitable for all systainer®-generations except Systainer³ L, XXL, Systainer³ Organizer L, Systainer³ ToolBox L, Systainer³ S MINI-, MIDI-, MAXI-systainer®
- Telescopic rails are suitable for 32 mm hole line for a variable positioning of the systainer® in your individual furnishing system
- High quality full extension slide allows to open the lid of the systainer® completely
- Centred operating element in anthracite for locking / unlocking. Simple and fast self-assembly
- Individual labelling possible thanks to integrated field for plug-in cards. Barrel lock can be added
- Outside dimensions: H 57 x W 425 x D 376 mm
- Inside dimensions: H 50 x W 395 x D 300 mm
- Weight: 2.23 kg/pc.
- Carrying capacity: 20 kg



#### Barrel lock for drawer "SYS-AZ"

- Art n° 80101665
- Consists of a lock with 2 keys and a locking nut.
- For the safe storage of precious tools. Simple and fast self-assembly



## REPLACEMENT MADE EASY

We attach great importance to flexibility and a long product life. Therefore, all systemer® components such as lid, handle or catches are easy to replace.

## SPARES



### Systainer³ catch

- For Systainer³ M, L, XXL, Systainer³ lid compartment M, Systainer³ Combi M, Systainer³ ToolBox
- 12 colors



### Systainer³ Organizer catch

- For Systainer³ Organizer
- 12 colors



### Systainer³ S catch

- For Systainer³ S 76 + 147, Systainer³ S 76, transparent lid
- 12 colors



### Systainer³ Compact catch

- Signal blue Art n° 83570026
- Anthracite Art n° 83570027



### Systainer³ Pin

- For all Systainer³ except Systainer³ S, Sortainer
- Light grey art n° 83570018
- Anthracite art n° 83570024



### Systainer³ lid handle

- For all Systainer³ except Systainer³ S, Organizer, ToolBox
- Light grey art n° 83570019
- Anthracite art n° 83570025



### Systainer³ M lid without handle + catch

- For Systainer³ M
- Light grey art n° 83570020



### Systainer³ L lid without handle + catch

- For Systainer³ L
- Light grey art n° 83570021



### Systainer³ front handle

- For Systainer³ heights with front handle 112-187, Systainer³ Organizer, Systainer³ lid compartment M 137+187
- Light grey art n° 83500329
- Anthracite art n° 83500330

## COLORS

	Standard colors			Additional colors								
Systainer³ catch												
Systainer³ Organizer catch												
Systainer³ S catch												
Systainer³ Compact catch												
Systainer³ lid handle												

- 1) RAL 7035, light grey  
2) HKS 43 K, signal blue  
3) RAL 7016, anthracite

- 4) RAL 9004, black  
5) RAL 1007, daffodil yellow  
6) RAL 2011, deep orange

- 7) RAL 3002, carmine red  
8) RAL 5015, sky blue  
9) RAL 5003, sapphire blue

- 10) RAL 6001, emerald green  
11) HKS 54 K, signal green  
12) RAL 9016, white



## SPARES



### T-Loc catch

- For systainer® T-Loc I-V, MIDI-systainer® T-Loc II + III, systainer T-Loc “SYS-Combi II + III”
- 12 colors



### T-Loc catch

- For MINI-systainer® T-Loc I + III
- 12 colors



### SYS-Sort catch

- For Sortainer T-Loc “SYS-Sort IV / 3”
- 12 colors



### Catches

- For MAXI-systainer®, Drawer-systainer®, Rack-systainer®, systainer® Tool-Box 1 + 2 and systainer® Storage-Box
- 11 colors



### Pin





- For systainer® T-Loc I - V lid, MIDI-systainer® T-Loc II + III, systainer® T-Loc “SYS-Combi II + III”
- Light grey art n° 83570102
- Anthracite art n° 83570103



### T-Loc handle

- For systainer® T-Loc I - V, MIDI-systainer® T-Loc II + III, systainer® T-Loc “SYS-Combi II + III” and Sortainer T-Loc “SYS-Sort IV / 3”
- Light grey art n° 83570081
- Anthracite art n° 83570082

## COLORS

	Standard colors	Additional colors
T-Loc catch	 <sup>2)</sup>  <sup>3)</sup>	 <sup>1)</sup>  <sup>4)</sup>  <sup>5)</sup>  <sup>6)</sup>  <sup>7)</sup>  <sup>8)</sup>  <sup>9)</sup>  <sup>10)</sup>  <sup>11)</sup>  <sup>12)</sup>
SYS-Sort catch	 	         
Catches	 	        
T-Loc handle	 <sup>1)</sup> 	        

- 1) RAL 7035, light grey  
2) HKS 43 K, signal blue  
3) RAL 7016, anthracite

- 4) RAL 9004, black  
5) RAL 1007, daffodil yellow  
6) RAL 2011, deep orange

- 7) RAL 3002, carmine red  
8) RAL 5015, sky blue  
9) RAL 5003, sapphire blue

- 10) RAL 6001, emerald green  
11) HKS 54 K, signal green  
12) RAL 9016, white

## SPARES



### T-Loc lid without handle + catch

- For systainer® T-Loc I-V, systainer® T-Loc „SYS-Combi II + III“
- Light grey art n° 83570120



### Slide for “SYS-CART”, set of 2

- Signal blue art n° 80590811
- Anthracite art n° 80590957



### Sliding rails for “SYS-Roll”, set of 2

- Black art n° 83570144



### Thermal switch for “SYS-PH”

- Art n° 83570133



### Cable with plug for “SYS-PH”

- EU art n° 83570134
- DK art n° 83570135
- CH art n° 83570136
- GB art n° 83570137



### Socket for “SYS-PH”

- TYP F (DE/NL/SE/AT/HU/FI/LT) art n° 83570138
- TYP F (IT/ES) art n° 83570139
- TYP K (DK) art n° 83570140
- TYP J (CH) art n° 83570141
- TYP G (GB) art n° 83570142
- TYP E (FR/BE/CZ/SK/PL) art n° 83570143

## SPARES – MOBILE WORKSHOP



1

**Work surface made of MDF for Mobile Workshop MW 1000 Basic**

- Art n° 80591089
- Dimensions: 445 x 363 mm
- Incl. fastening materials



2

**Work surface made of MDF for table TSB/1-MW 1000**

- Art n° 80591086
- Dimensions: 970 x 445 mm
- Incl. fastening materials



3

**Slide element for Mobile Workshop MW 1000 Basic**

- Art n° 80591088
- 2 pieces
- Incl. fastening materials



4

**Spacer for Mobile Workshop MW 1000 Basic**

- Art n° 80591090
- Set of 2



5

**Foot for Mobile Workshop MW 1000 Basic and table TSB/1-MW 1000**

- Art n° 80591087



6

**Table connector for table TSB/1-MW 1000**

- Art n° 80591085
- Incl. fastening materials

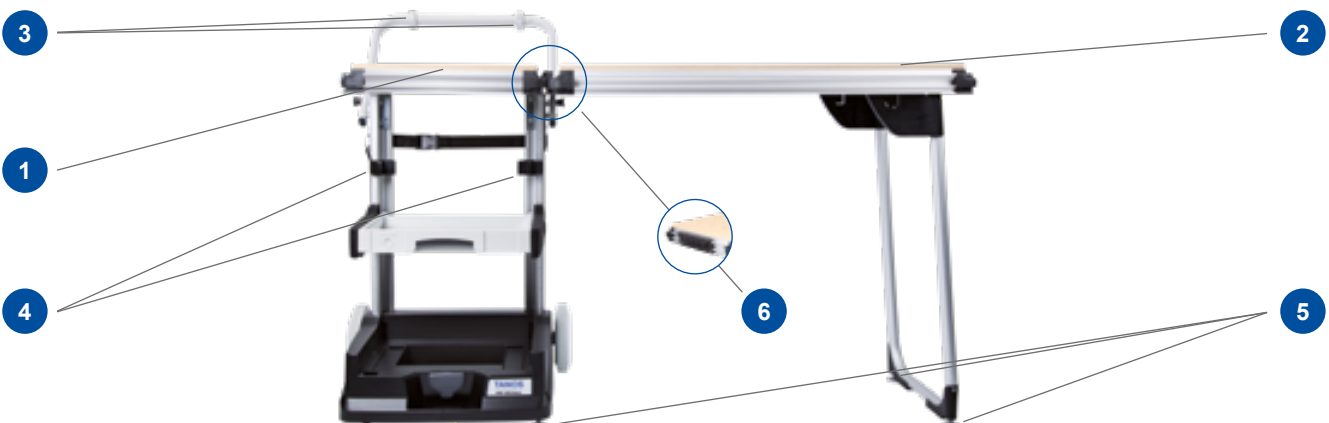

# TANOS

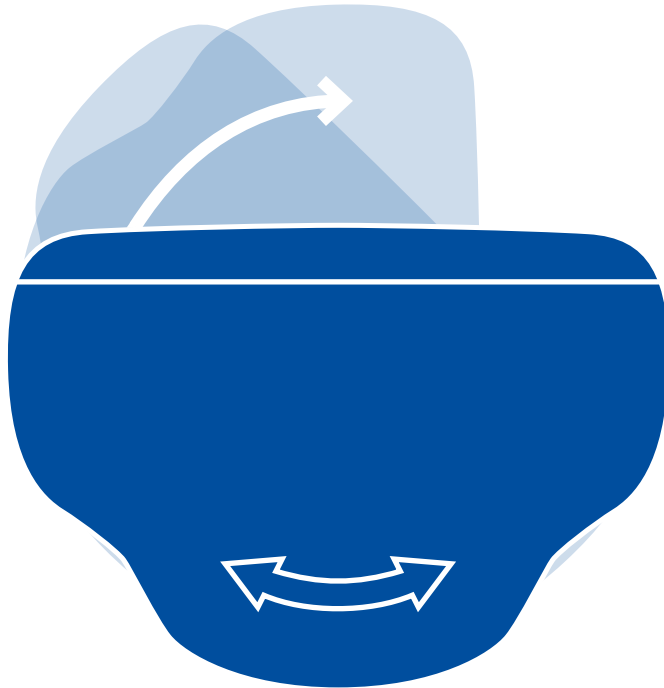

Systainer³

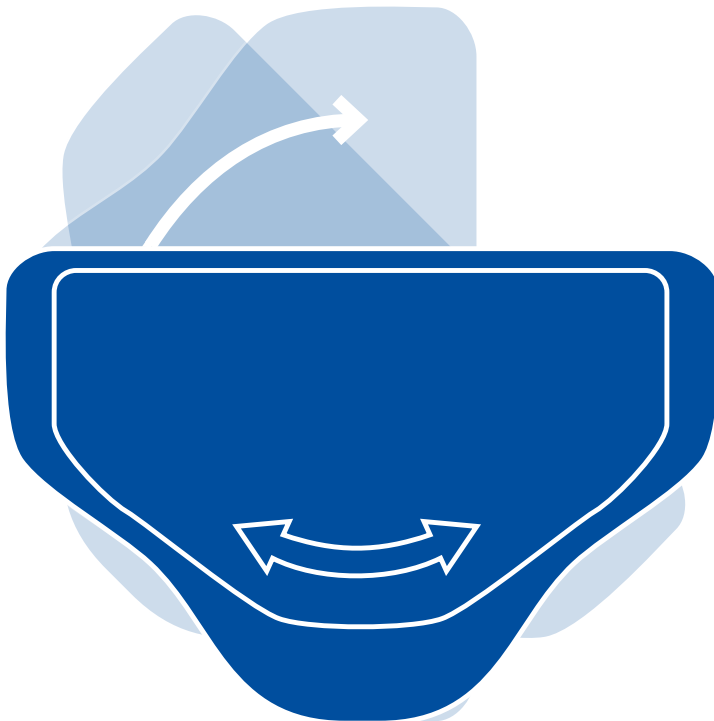

systainer® T-Loc

Illustrations in life size



systainer® CLASSIC-Line

## TANOS GmbH

Pionierstraße 1; D - 89257 Illertissen, Germany  
Phone +49 (0)7303 / 165 302 - 00; Fax +49 (0)7303 / 165 302 - 31  
info@TANOS.de; www.TANOS.de

Issue: 02/2024. We reserve the right to make product modifications, misprints and errors. Please consult the instructions before using any product. All illustrations are non-binding. Decorations and product examples not included in the scope of supply.

Art n° 80002869 | EN